

implantswiss.com

NOVODENT SA
Y-Parc Technopole
Avenue des Sciences 11
CH-1400, Yverdon-les-Bains
Switzerland

05.2023 Rev.06

 **implant** **swiss**
SMART
CHOICE

IMPLANT TECHNOLOGY



» Content

Implantswiss Dental System	2
Swiss Master Precision	4
Product Traceability	5
Glass Package	6
Platform Color Coding	7
» Implantswiss System Specifications	8
S.R.A. Surface	12
Hybrid Design	13
Conical Connection with Hexagonal Index	14
Platform Switching	14
Self Cutting Edge	15
Hygienic Neck Design	15
» Implantswiss Implants	16
Bone Level Implant	18
Tissue Level Implant	19
» Surgery	20
Implantswiss Surgical Drills and Protocols	22
» Short Implant	30
Short Implant	30
Short Implant Surgical Kit	33
Short Implant Surgical Drills and Protocols	34
» Zygoma Implant	38
Zygoma Implant Surgical Kit	41
» Implantswiss Prosthetic Components	42
» Bone Level System Prosthetic Components	44
Bone Level Healing Abutments	47
Couple System	47
Solid System	49
Octa System	50
O-ring System	51
Locator System	52
Multi-Unit System	53
Bar System	54
» Tissue Level System Prosthetic Components	55
Tissue Level Healing Abutments	58
Couple System	58
Solid System	59
Octa System	60
O-ring System	61
Locator System	62
» Zygoma Dental Implant System Prosthetic Components	63
» Digital Solutions	64
Bone Level Digital Solutions	66
Tissue Level Digital Solutions	67
Multi Unit Abutment Digital Solutions	68
Octa Abutment Digital Solutions	68
Ti-Base Abutment	69
» Index Code	70

implantswiss

Switzerland

is celebrated and acknowledged as a world authority in

science, mechanical design and craftsmanship



As a country Switzerland has been one of the most important centers of inventiveness that guarantees

high precision and proficiency

Swiss products with impeccable mechanical designs and exquisite ingenuity can be used for a lifetime and add artistry to life.

Implantswiss Dental Implant System derives its **exceptional** structure from the inspirational and the magnificent Swiss artisan history.

Implantswiss is a strong, reliable and unique brand in dental Implantology due to its innovative design, surface technology and high quality.

Implantswiss is dedicated to Research and Development through collaborations with universities and it supports crucial research investment in any clinical environment. Implantswiss follows the latest trends and helps initiate extensive and contemporary projects which will lead into the future of implant dentistry.

Implantswiss Dental System

is the most prosperous and most versatile Implant system in Dentistry offering a range of solutions to all the simple and complex clinical situations.



SWISS MASTER PRECISION



Implantswiss products are precisely manufactured with state-of-the-art technology and diligent quality control mechanisms.

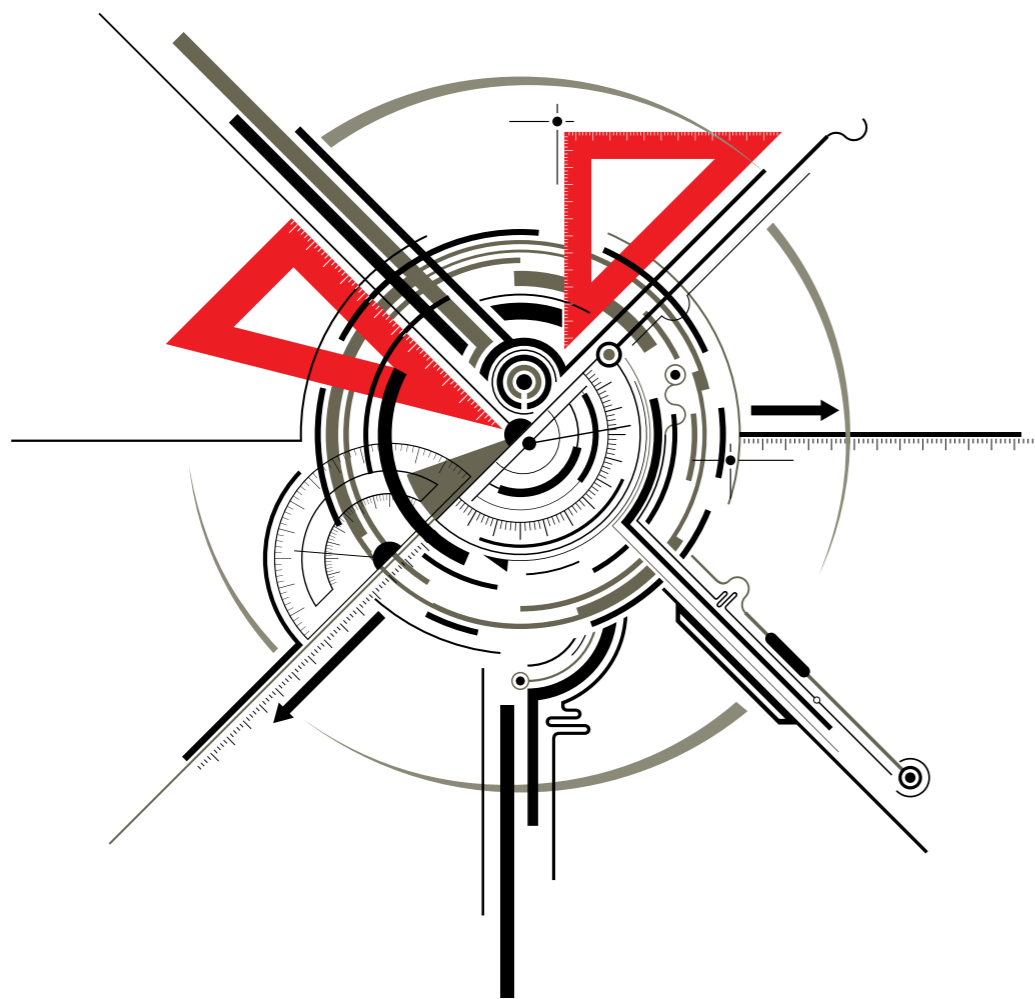

The perfectionist mindset of our Implantswiss team in each stage of the manufacturing and quality control process is the essence of our mission to deliver high quality and reliable products to the Dental world.

PRODUCT TRACEABILITY

Each Implantswiss product can be easily traced from production to delivery.

Each individual package has a barcode label with a lot number created by the ERP software system. All steps from production to stock, delivery and sales can be monitored with this barcode system; therefore, the traceability process is conducted flawlessly.

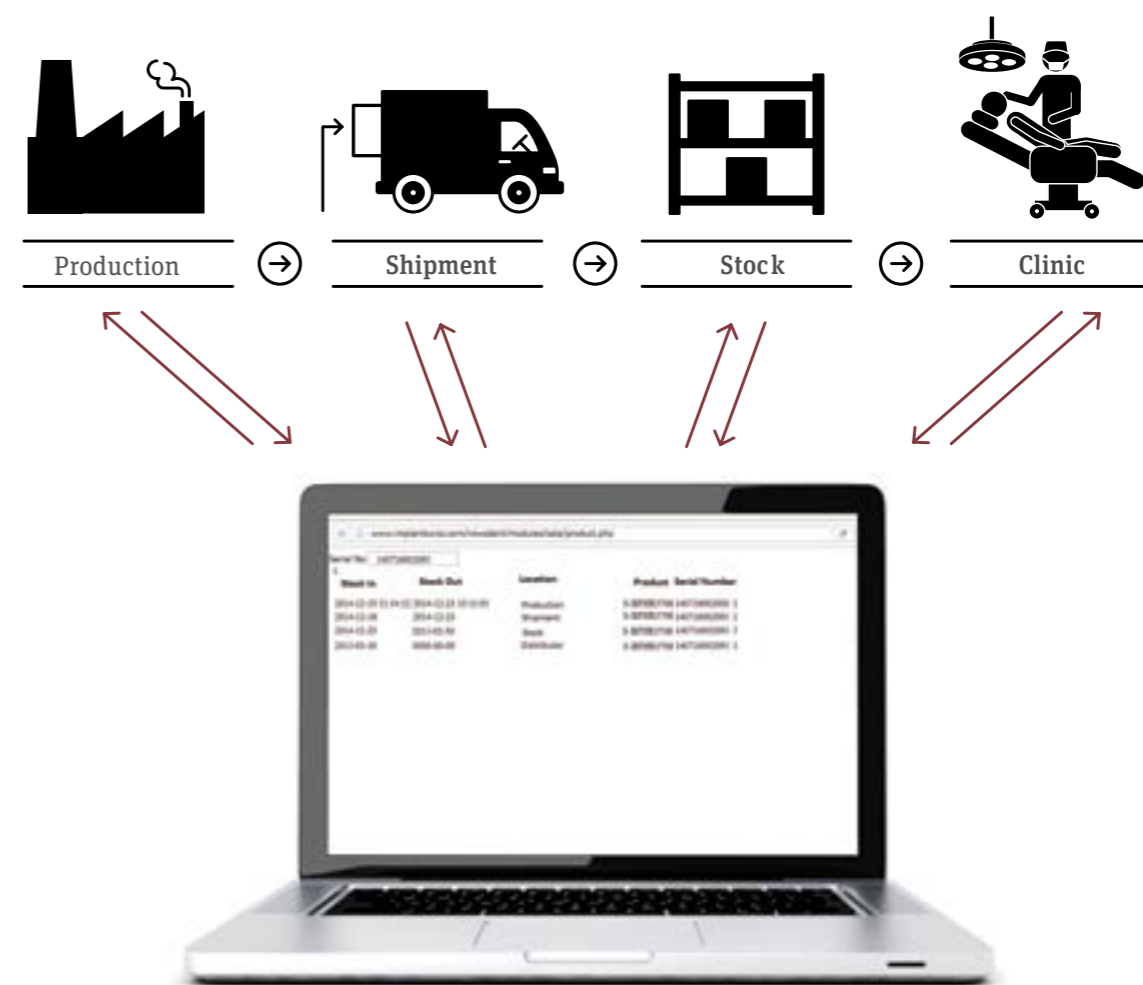

GLASS PACKAGE

GLASS PACKAGING

The preservation of nature and human health have always been the primary concern for Implantswiss. As a responsible supplier Implantswiss is aiming to limit the use of plastics in our packaging. Therefore, all Implantswiss Implants are packed in 100% natural and hygienic glass vials.

Since the glass structure is inert, glass packages are especially preferred over plastic containers for preserving the high value products.

High barrier property, ease of sterilization and nonreactivity to chemical substances, are few of the many advantages of glass packaging.

SMART PACKAGING

The implant can be simply removed from the glass bottle and placed in the osteotomy site using the specific fixture driver.

Each product package has a label containing all necessary information about the implant such as its type, length, width and platform color coding.

The platform color coding depicts the associated diameters of the implants and prosthetic components, the products are color coded as below.



PLATFORM COLOR CODING



TISSUE LEVEL

BONE LEVEL



» IMPLANTSWISS
SYSTEM
SPECIFICATIONS

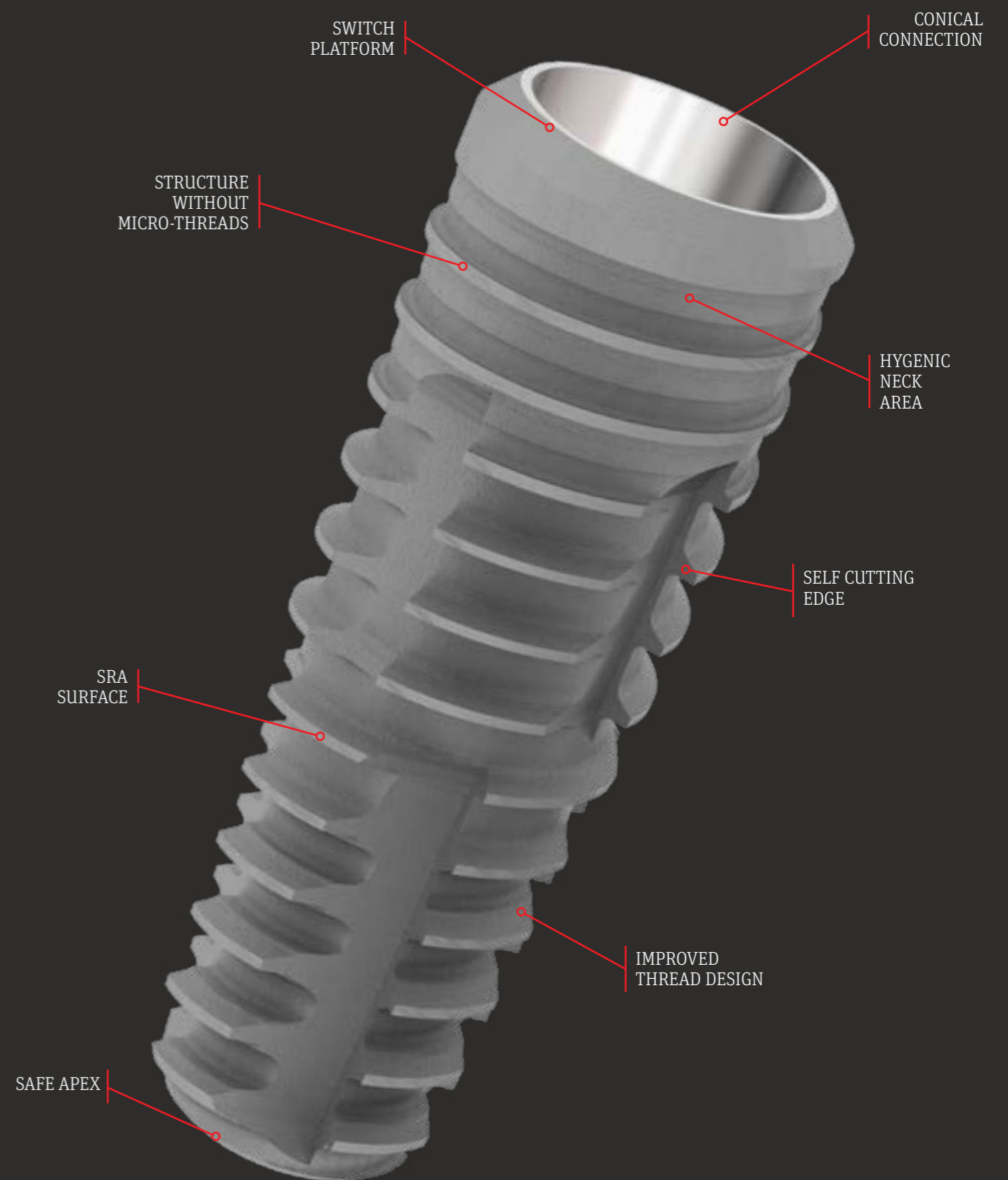

» SRA* Surface

To ensure maximum Osseointegration after sandblasting, the surface of the implant is etched using Double Acid Etching technique.

Implantswiss S.R.A. surface has a unique homogeneous surface roughness that perfectly mimics the bone morphology.

* Sandblasted Rough Acid-etched Surface

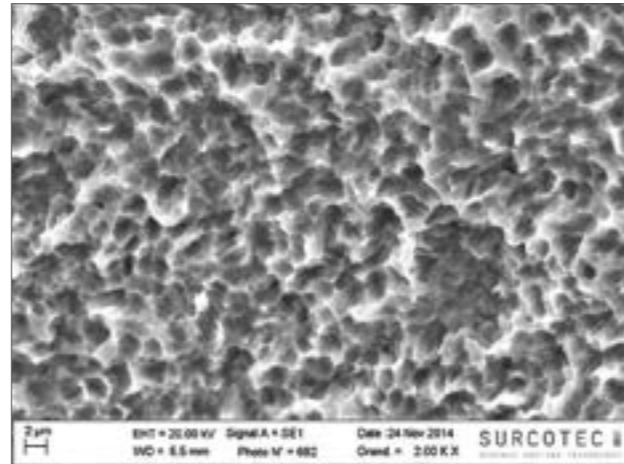

3D-Area Parameters

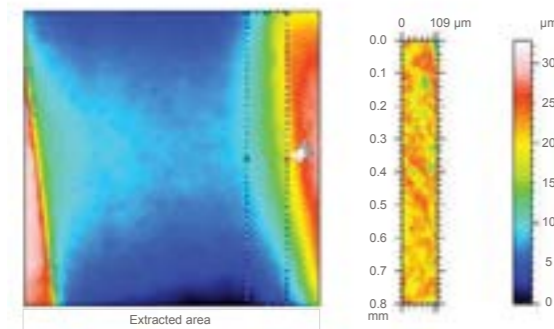

Detail of the thread Bank and representation of the surface shape after removal of a 4th order polynomial

ISO 25178				
Height Parameters				
Sa	1,80	µm		
Sq	2,44	µm		
Feature Parameters				
S10z	15,1	µm	pruning = 5%	Ten point height
S5p	8,59	µm	pruning = 5%	Five point peak height
S5v	6,49	µm	pruning = 5%	Five point of height

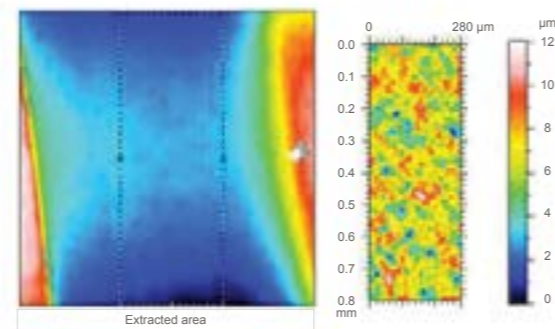

Detail of the thread valley and representation of the surface shape after removal of a 4th order polynomial

ISO 25178				
Height Parameters				
Sa	1,25	µm		
Sq	1,60	µm		
Feature Parameters				
S10z	9,16	µm	pruning = 5%	Ten point height
S5p	3,39	µm	pruning = 5%	Five point peak height
S5v	5,76	µm	pruning = 5%	Five point of height

» Tapered form + Straight form =

Hybrid Design

It is a unique & innovative hybrid implant design with cylindrical (straight) configuration at the neck area and conical (tapered) configuration at the apex of the implant.

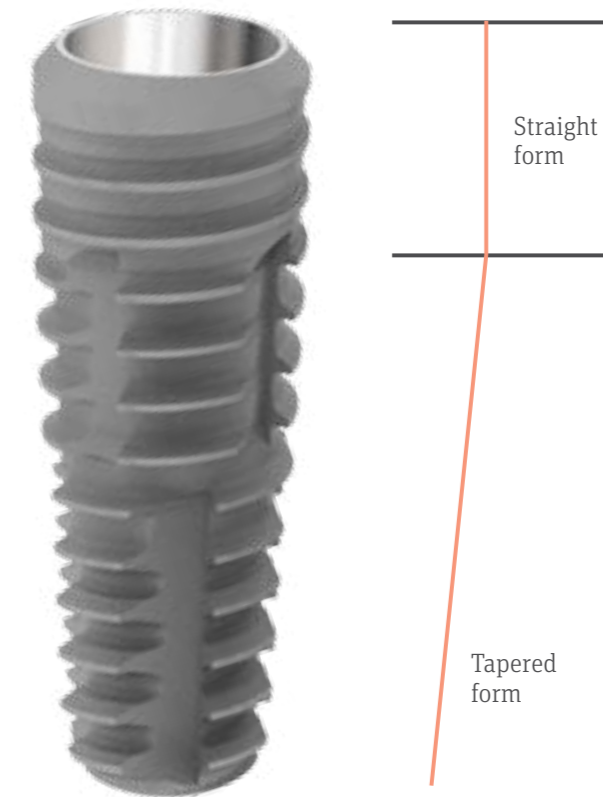

The top 3 mm of Implantswiss implant is straight downward from the neck which constitutes the straight form, however the remaining apical portion of implant constitutes the tapered form at a certain angle. The optimum combination of these two specifications creates our hybrid design.

The straight portion at the top of our unique hybrid design exerts minimal stress on the crucial crestal cortical bone leading to an optimal load distribution. The tapered portion of the design facilitates easy insertion of the implant at osteotomy site

» Conical connection with hexagonal index

creates a secure and steady implant-abutment connection

The universal conical connection and hexagonal index of our implant creates a firm and sound implant-abutment interface, which prevents the formation of micro gap and hence micro leakage.

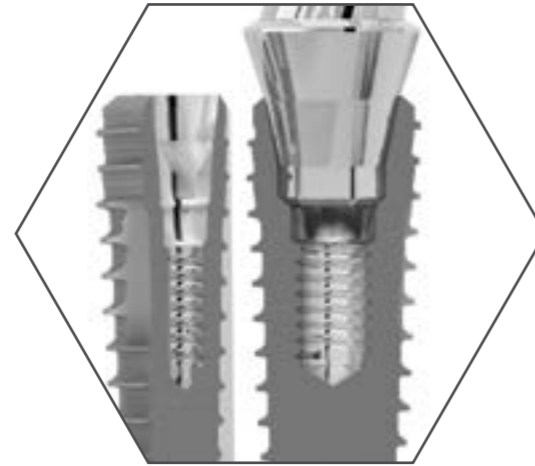

» Platform Switching

Maintains the crestal alveolar bone around the neck area of the implant.

Micro-gap can be formed at the implant-abutment interface in Bone Level implants especially if they have a butt joint connection. Pathogens and their by-products in these areas can cause serious problems such as bone resorption and peri-implantitis.

Although Implantswiss Implants have a sealed conical connection, Platform switching further protects & maintains cervical bone by moving the implant-abutment interface away from the alveolar bone. Implantswiss Implants with Platform switch characteristic are safer against bacteria and microleakage, thus have a longer life span.



» Self Cutting Edge

Unique thread design that does not transfer stress to the bone.

Implantswiss implants have a particular thread design which does not transfer stress to the bone during insertion. Semi-aggressive thread design with cutting edge and self-cutting features provide ideal primary stability in any bone type without transferring unfavorable stress to the bone.



» Hygienic Neck Design

Easy to maintain the hygiene

Harmful pathogens can easily colonize in the micro threads at the cervical area of some implant designs. The absence of micro threads at the cervical area of Implantswiss Implants make it easier to maintain hygiene and plaque control. Due to this feature, plaque around the neck of the Implants is less retentive and hence less chances of bone resorption.

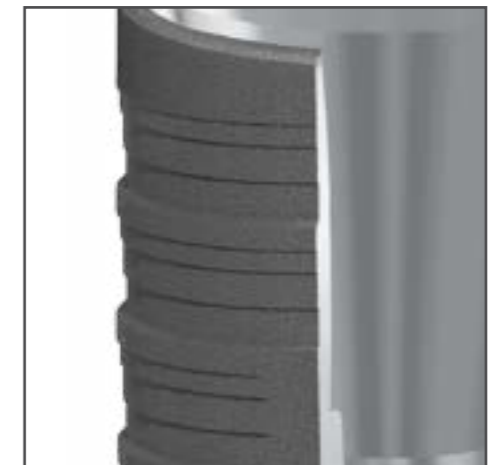

» IMPLANTSWISS
IMPLANTS



BONE LEVEL IMPLANT



Bone Level implants are designed to provide excellent outcomes in any bone quality and at any site.

Due to their unique design, Implantswiss bone level implants allow you to design an ideal smile in the aesthetic zone.

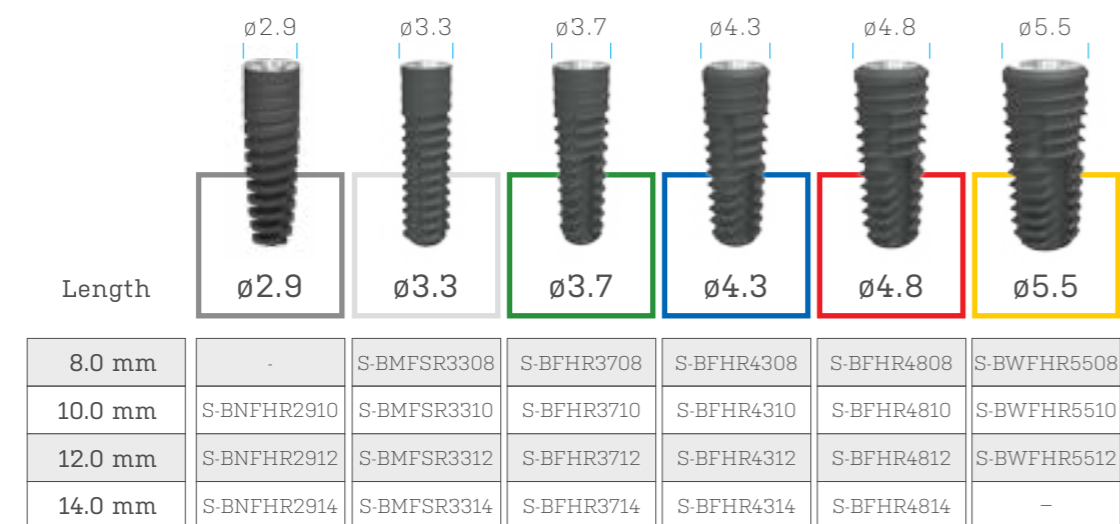

System » Bone Level
Material » Ti Grade 4
 Ti Grade 5 for 2.9 implant
Driver » Bone Level driver,
 Mini Bone Driver for 3.3 implant
 Narrow Driver for 2.9 implant
Torque Value » 35 Ncm

TISSUE LEVEL IMPLANT



Excellent soft and hard tissue preservation can be achieved successfully with the smooth neck, at the implant-abutment interface of our Tissue Level implant.

The implant is designed to provide excellent outcomes in any situation where the aesthetic outcome is not the primary concern.

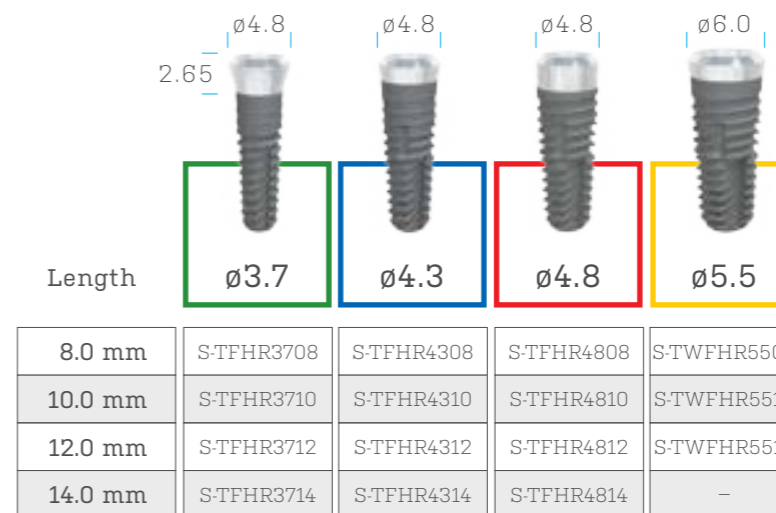

System » Tissue Level
Material » Ti Grade 4
Driver » Tissue level driver
Torque Value » 35 Ncm

» SURGERY

BONE LEVEL - TISSUE LEVEL

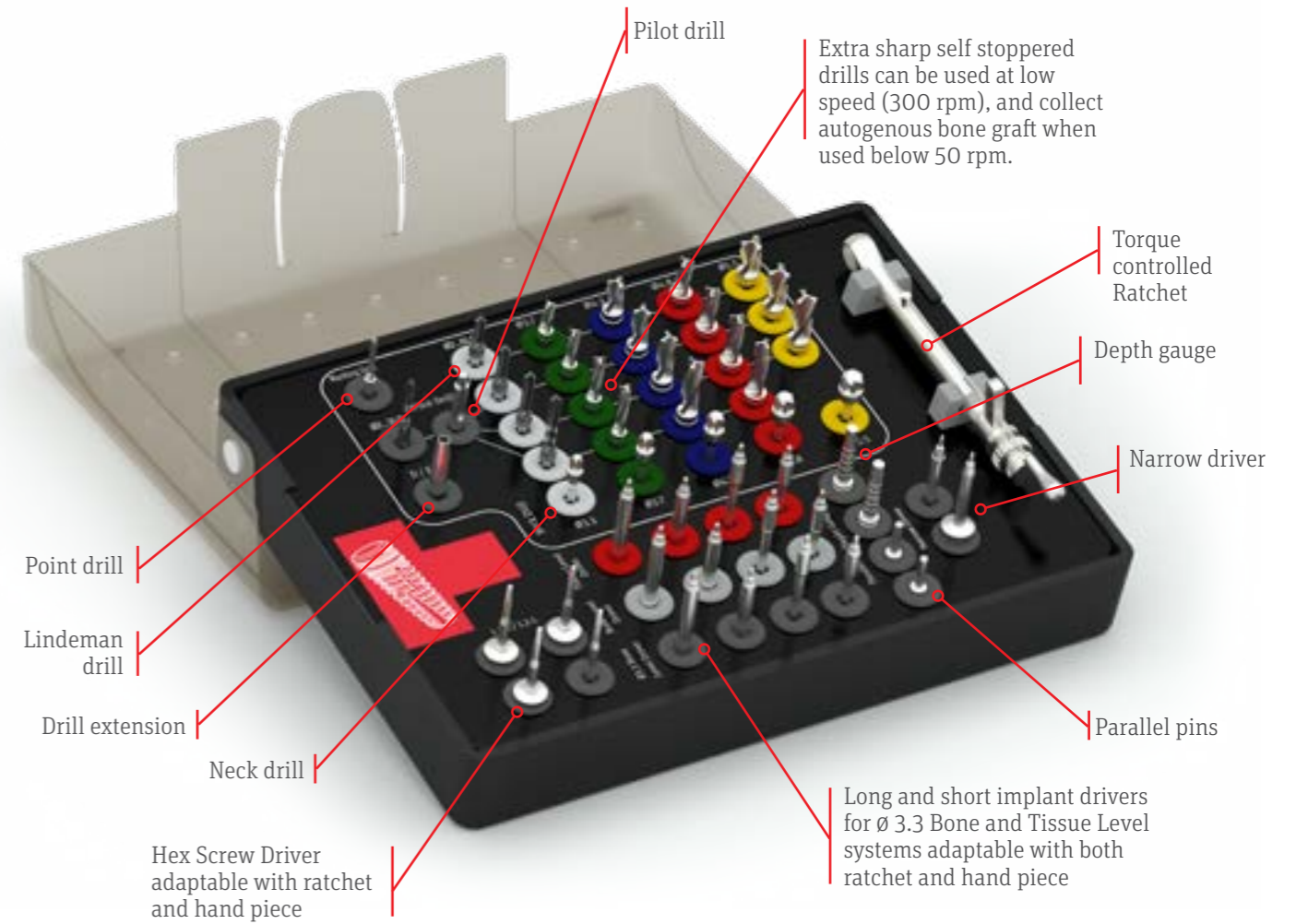

IMPLANTSWISS FIXTURE DRILLS & PROTOCOLS

SURGICAL DRILLS & PROTOCOLS

Self-stoppered surgical drills eliminate the risk of complications during the preparation of the osteotomy site and insertion of the implant. Implantswiss drills are recommended to be used at 200-300 rpm to prevent overheating and reduce mechanical trauma, therefore shortening the osseointegration time of the implant. The drills are designed to harvest the autogenous bone when used below 50RPM without irrigation, which can be used as a graft material in regenerative procedures.

The Implantswiss Surgical Kit has color-coded drills for each implant type available in the system.

The Implantswiss Surgical Kit has various drills with different diameters and lengths. These color-coded drills are designed to simplify the surgical procedures, resulting in shorter surgery time and less stress for your patients.

SURGICAL DRILLS

2.2 Lindeman drill 2.8 Lindeman drill 3.7 drill 4.3 drill 4.8 drill 5.5 drill



AUXILIARY DRILLS

Point drill Pilot drill Neck drill



D1-D2-D3-D4
Bone

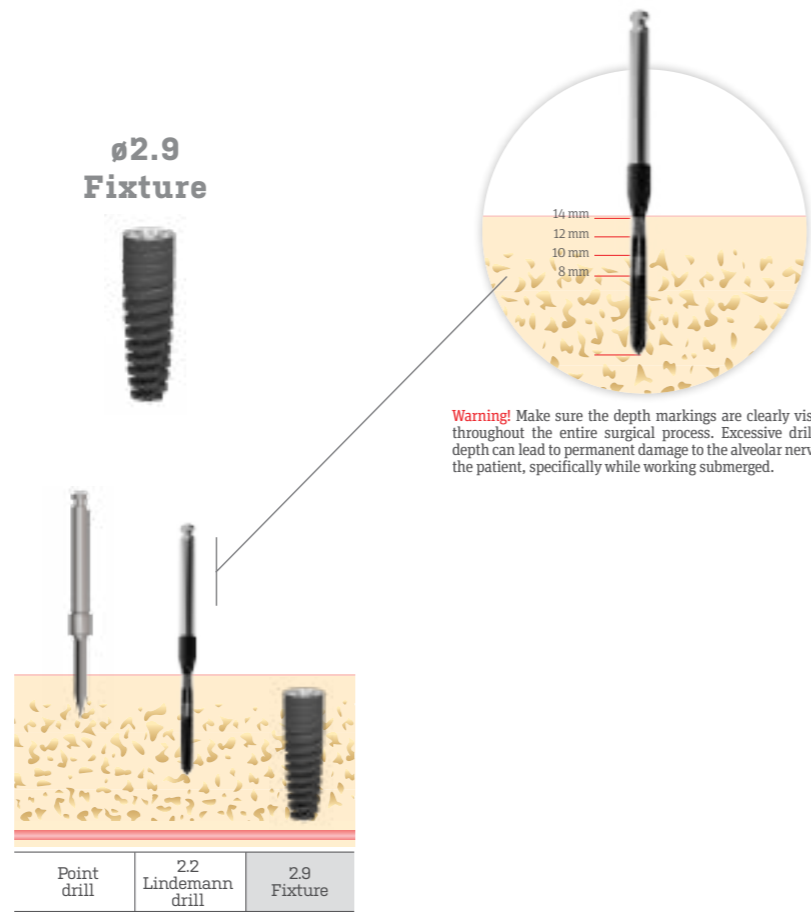

D1 Bone

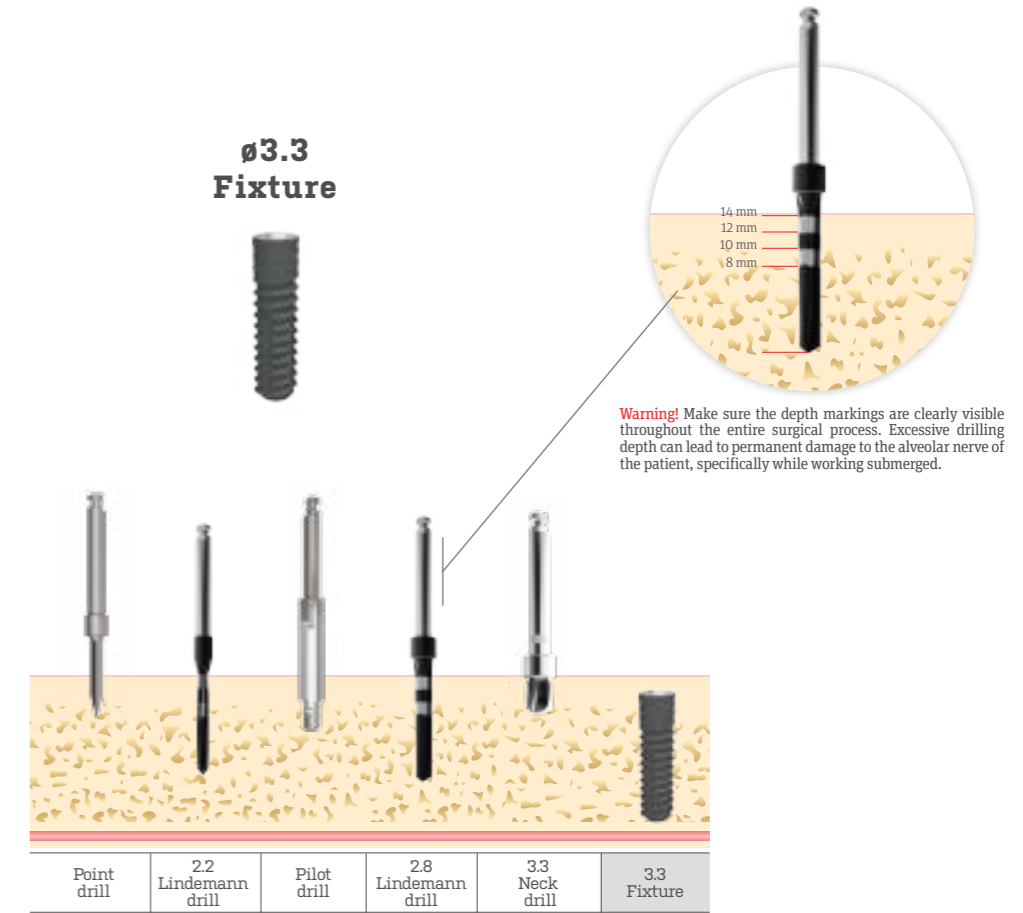

D2-3 Bone

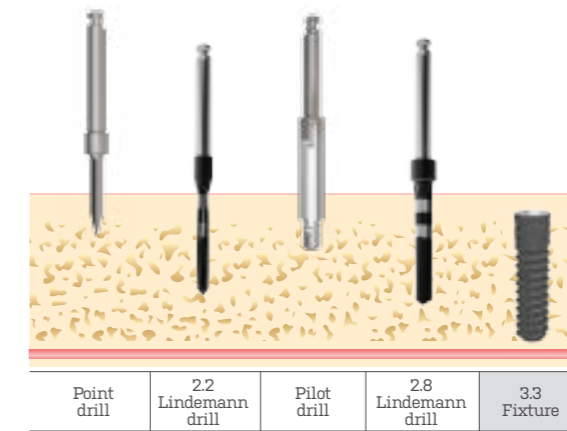

D4 Bone

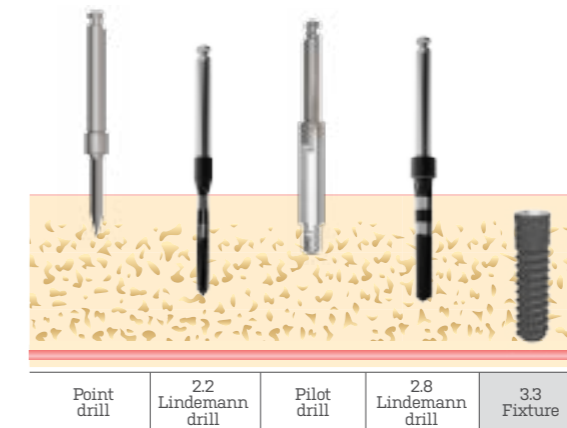

Note: It is recommended to place the implants 1 - 2 mm subcrestal

**ø3.7
Fixture**

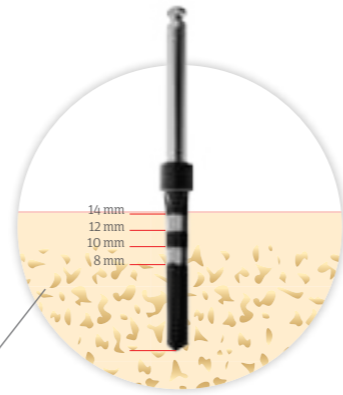

Warning! Make sure the depth markings are clearly visible throughout the entire surgical process. Excessive drilling depth can lead to permanent damage to the alveolar nerve of the patient, specifically while working submerged.

D1 Bone

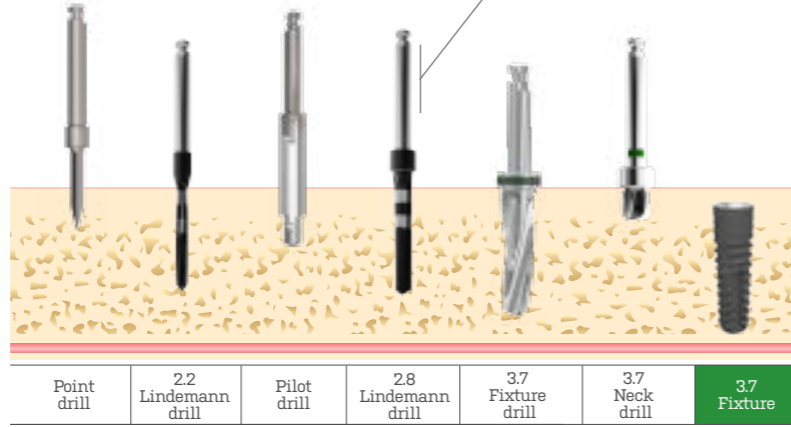

D2-3 Bone

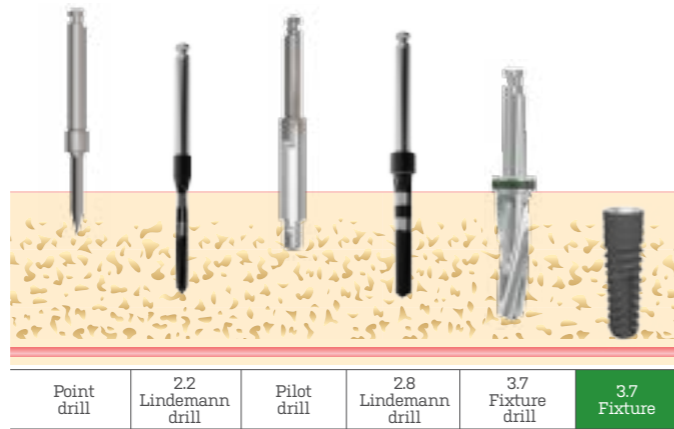

D4 Bone

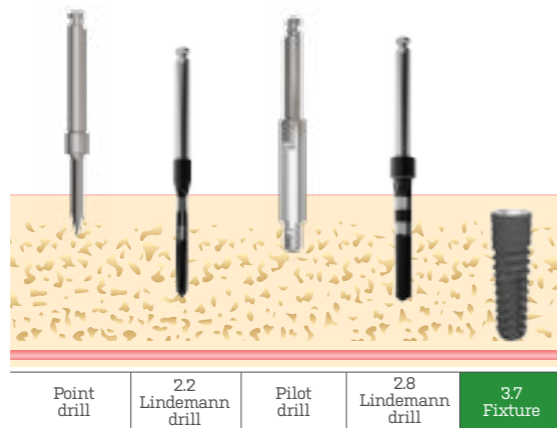

**ø4.3
Fixture**

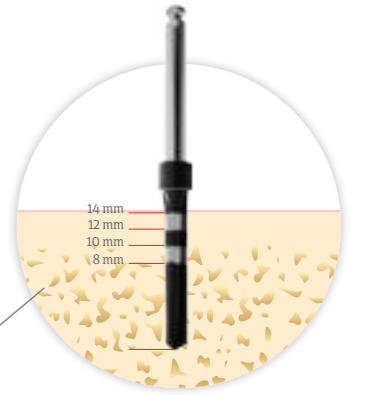

Warning! Make sure the depth markings are clearly visible throughout the entire surgical process. Excessive drilling depth can lead to permanent damage to the alveolar nerve of the patient, specifically while working submerged.

D1 Bone

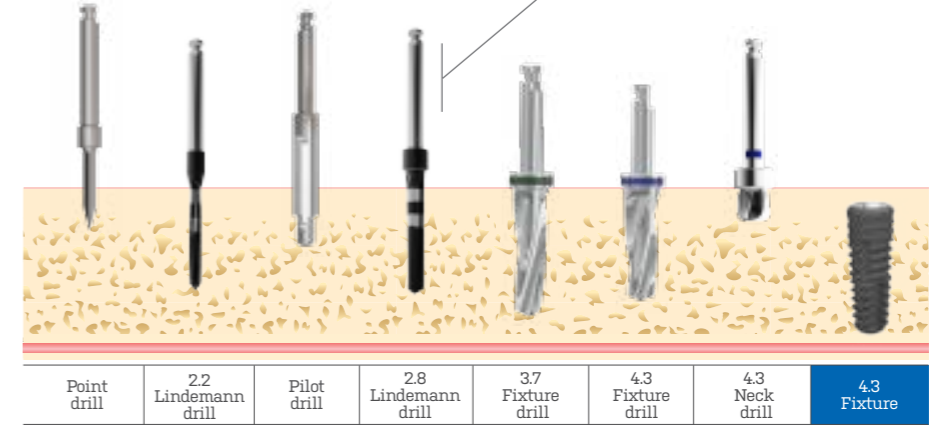

D2-3 Bone

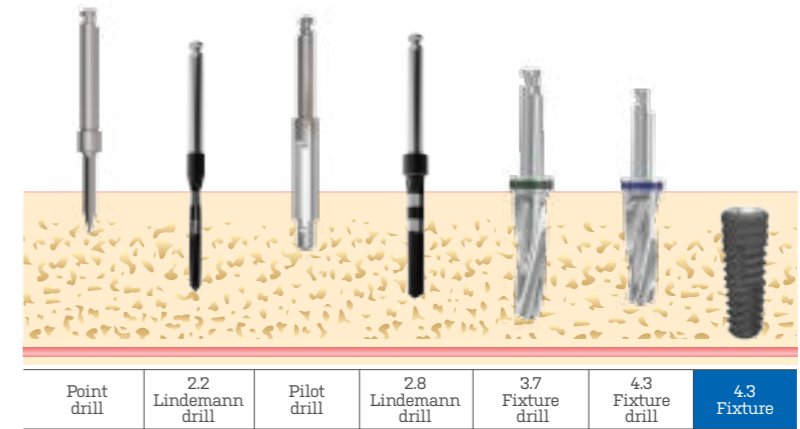

D4 Bone

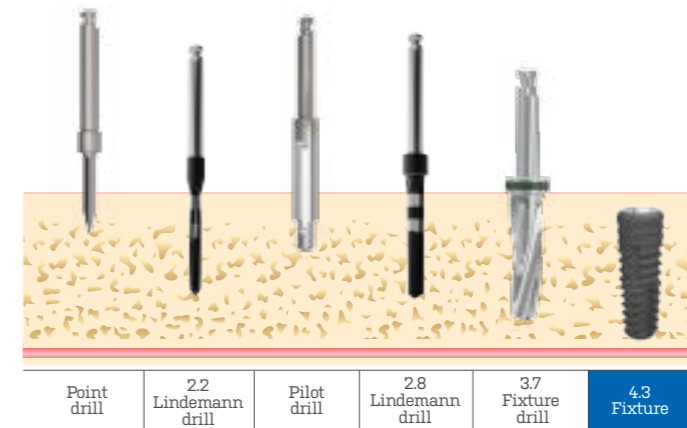

**ø4.8
Fixture**

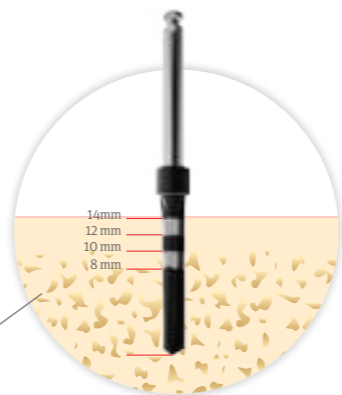

Warning! Make sure the depth markings are clearly visible throughout the entire surgical process. Excessive drilling depth can lead to permanent damage to the alveolar nerve of the patient, specifically while working submerged.

D1 Bone

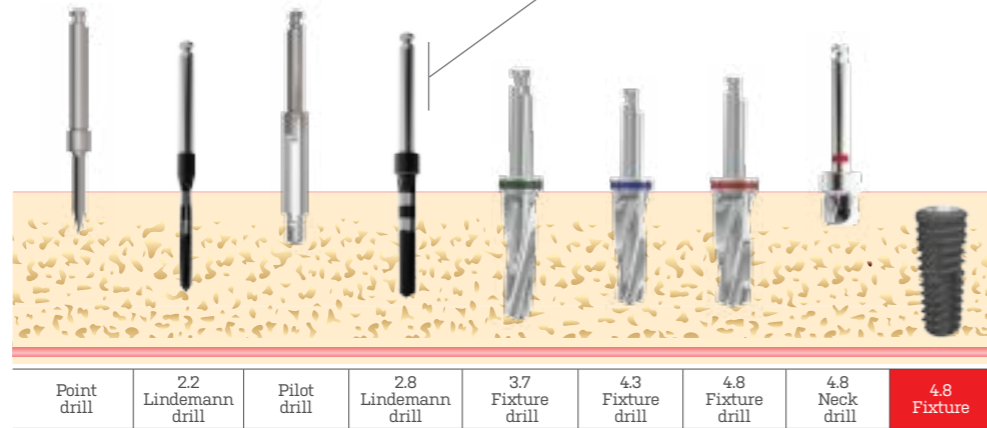

D2-3 Bone

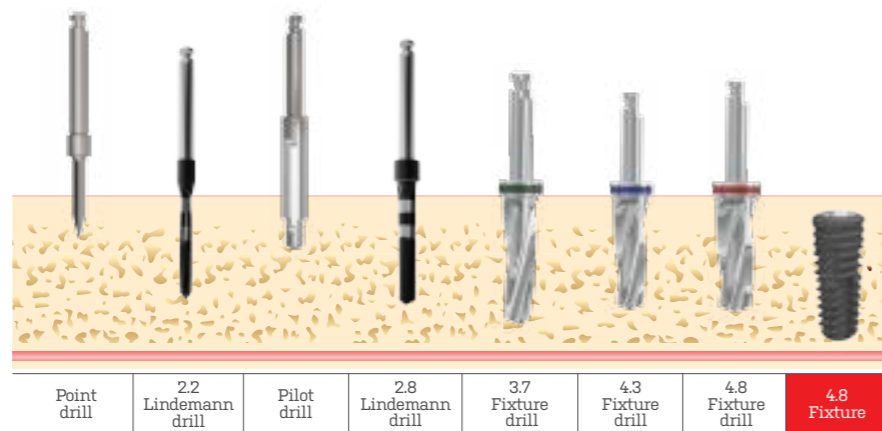

D4 Bone

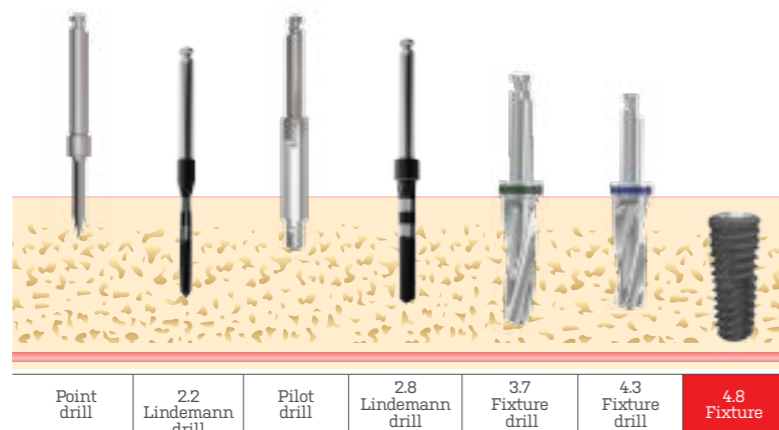

**ø5.5
Fixture**

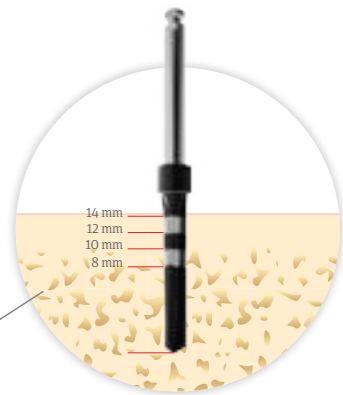

Warning! Make sure the depth markings are clearly visible throughout the entire surgical process. Excessive drilling depth can lead to permanent damage to the alveolar nerve of the patient, specifically while working submerged.

D1 Bone

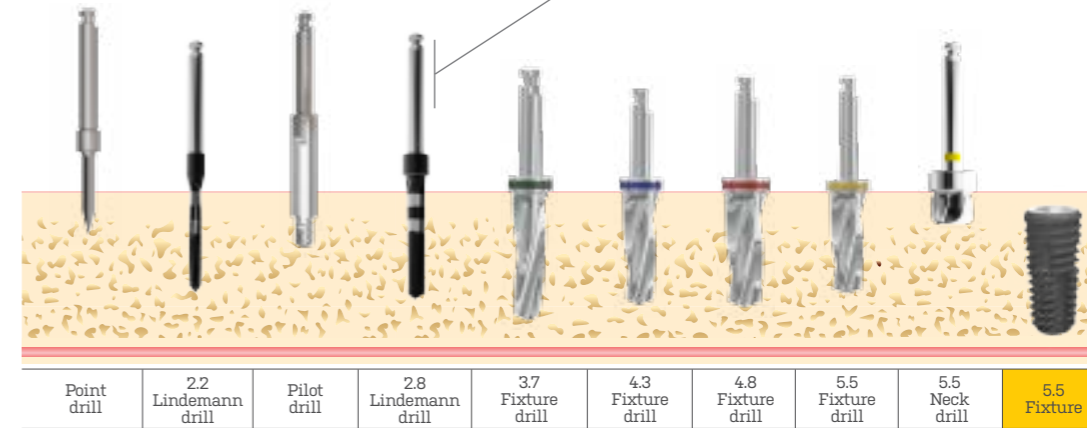

D2-3 Bone

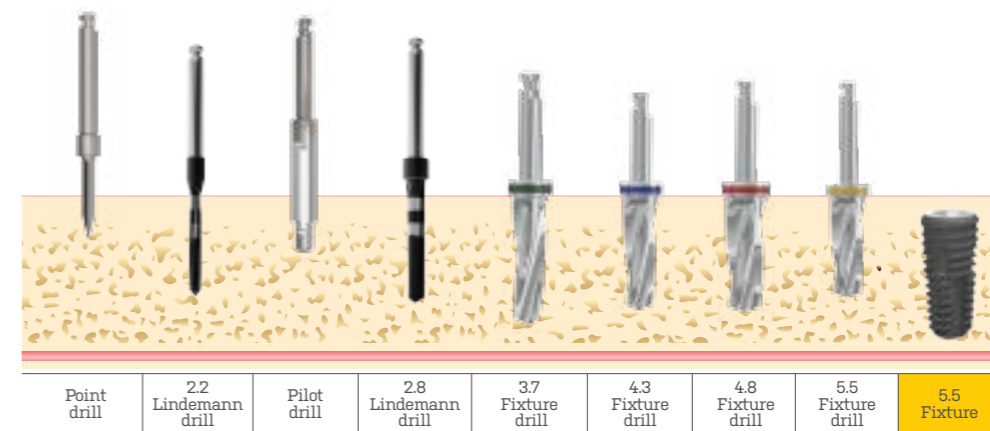

D4 Bone

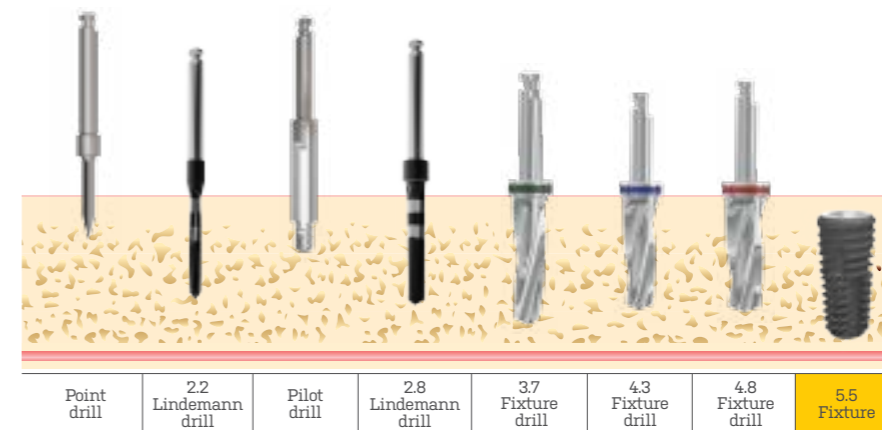

» **IMPLANTSWISS
SHORT IMPLANTS**



SHORT IMPLANT

Short implants are considered as an alternative treatment to advanced surgical interventions in case of insufficient bone height, either above the mandibular canal or below the maxillary sinuses and aim to regenerate hard tissues.

Due to the aggressive thread design, Bone level short implants can preferably be used in the maxilla where the alveolar bone is relatively soft, whereas Tissue level short implants can be a good choice for the mandible.

BONE LEVEL

Length	Ø4.3	Ø4.8	Ø5.5
5.0 mm	S-BMFSR4305	S-BMFSR4805	S-BMFSR5505
6.0 mm	S-BMFSR4306	S-BMFSR4806	S-BMFSR5506

TISSUE LEVEL

Length	Ø4.3	Ø4.8	Ø5.5
4.0 mm	S-TFSR4304	S-TFSR4804	S-TWFSR5504
5.0 mm	S-TFSR4305	S-TFSR4805	S-TWFSR5505
6.0 mm	S-TFSR4306	S-TFSR4806	S-TWFSR5506

GH > 265 mm

SHORT IMPLANT SURGICAL KIT

The short surgical kit is recommended for both Bone and Tissue Level short implants.



SHORT IMPLANT DRILLS & PROTOCOLS

The Implantswiss Short Implant Surgical Kit has a specific drill for each implant available in the system.

SURGICAL DRILLS	Tissue Level Fixture Drills			Bone Level Fixture Drills		
	4.3	4.8	5.5	4.3	4.8	5.5
						

Implantswiss Short Implant Surgical Kit has various color-coded drills with different diameters and lengths. These drills are designed to simplify the surgical procedures resulting in shorter surgery time and less stress for the patients.

AUXILIARY DRILLS	Point drill	Pilot drill
		

BONE LEVEL

D4 / D3 / D2 Bone



D1 Bone

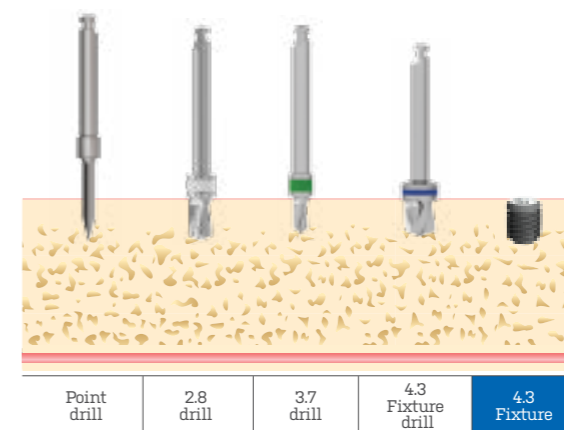

TISSUE LEVEL

D2 / D1 Bone

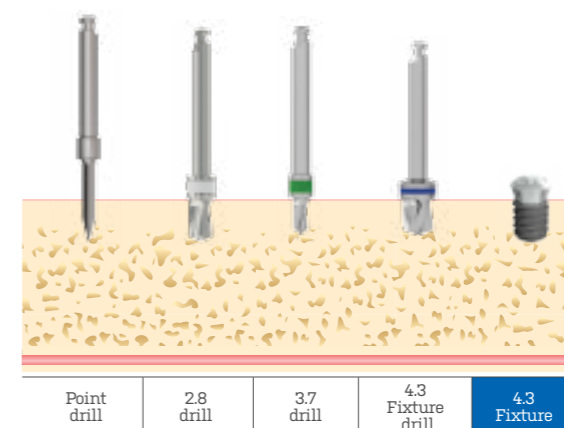

**ø4.8
Fixture**



BONE LEVEL

D4 / D3 / D2 Bone

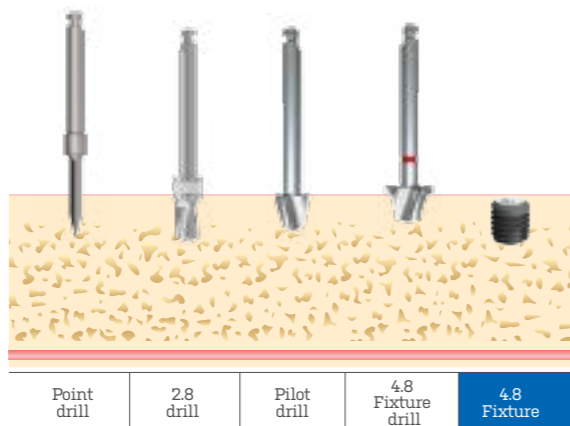

D1 Bone

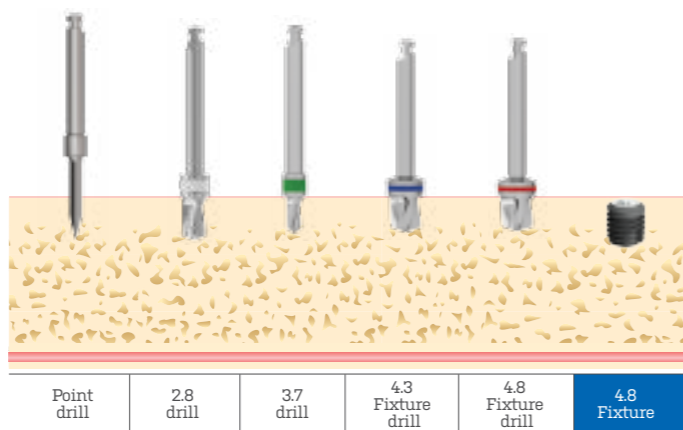

TISSUE LEVEL

D2 / D1 Bone

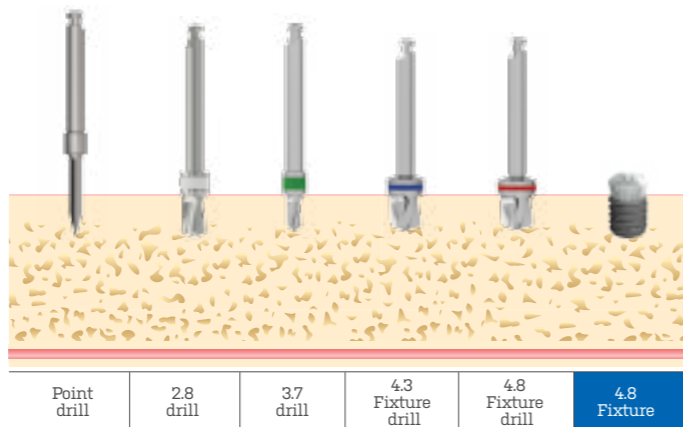

**ø5.5
Fixture**



BONE LEVEL

D4 / D3 / D2 Bone

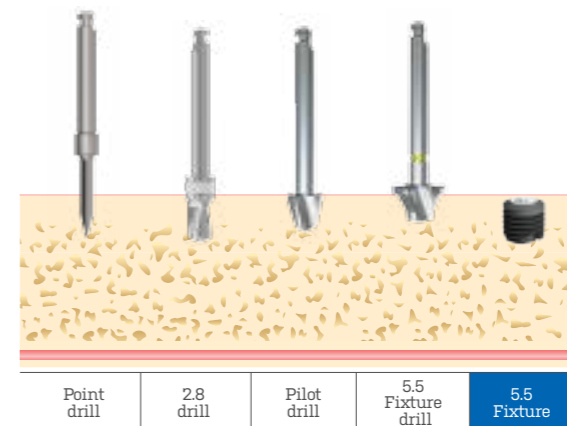

D1 Bone

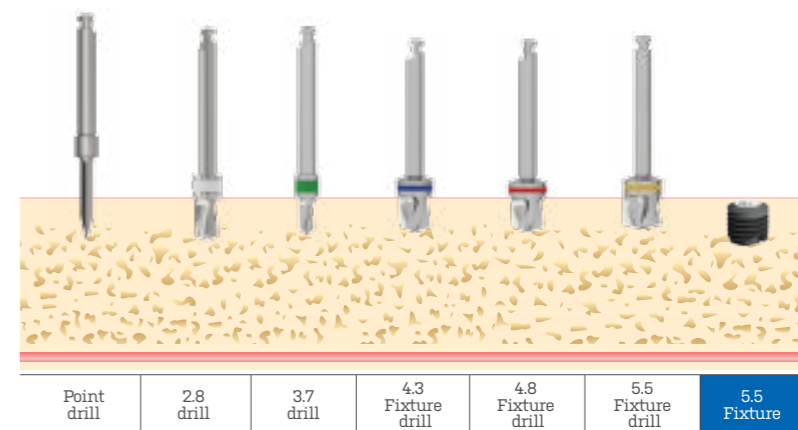

TISSUE LEVEL

D2 / D1 Bone

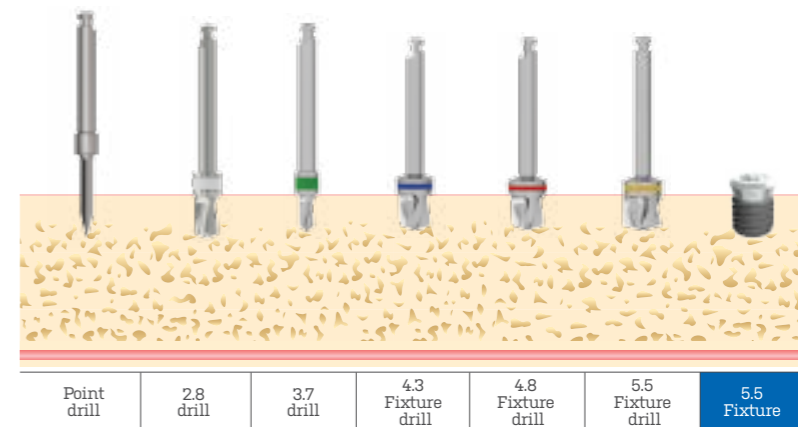

» **IMPLANTSWISS
ZYGOMA IMPLANTS**



ZYGOMA IMPLANT

Zygomatic implants are designed for complex cases where conventional implants cannot be used and for patients who want to benefit from immediate loading protocols. Even in the presence of minimum residual maxillary bone height, zygomatic implants provide excellent primary stability.

ZYGOMA Implant





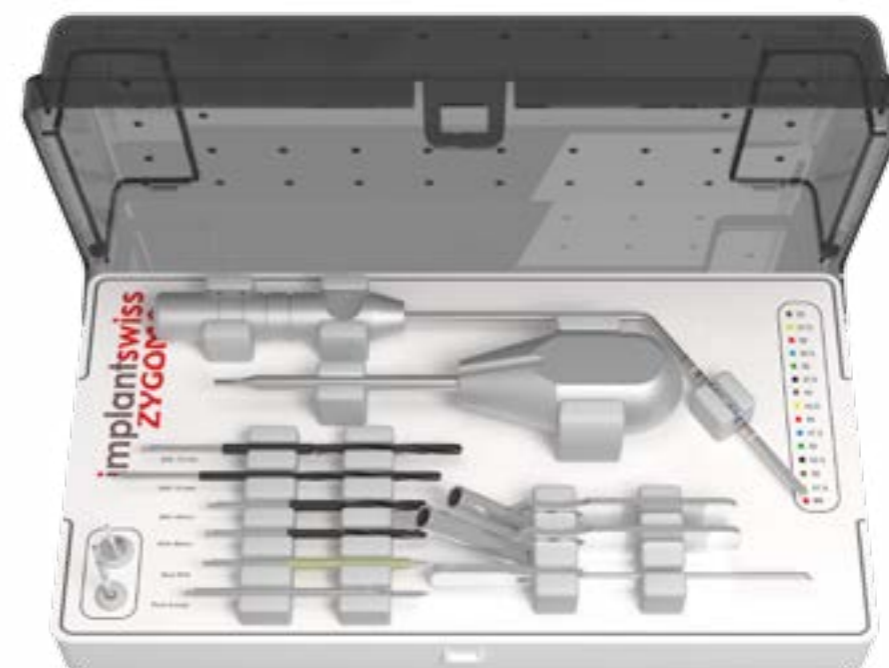

	Ø4.0
35 mm	S-ZYG35
37.5 mm	S-ZYG37.5
40 mm	S-ZYG40
42.5 mm	S-ZYG42.5
45 mm	S-ZYG45
47.5 mm	S-ZYG47.5
50 mm	S-ZYG50
52.5 mm	S-ZYG52.5
55 mm	S-ZYG55
57.5 mm	S-ZYG57.5
60 mm	S-ZYG60



ZYGOMA IMPLANT SURGICAL KIT



SURGICAL DRILLS

ZYGOMA DIAMOND BURR		S-ZBURN
ZYGOMA POINT DRILL		S-PD2970
ZYGOMA TWIST DRILL 2,5 SHORT	 40 mm	S-TWD3565
ZYGOMA TWIST DRILL 2,5 LONG	 75 mm	S-TWD35100
ZYGOMA TWIST DRILL 2,9 SHORT	 40 mm	S-TWD2965
ZYGOMA TWIST DRILL 2,9 LONG	 75 mm	S-TWD29100

» **IMPLANTSWISS
PROSTHETIC COMPONENTS**



BONE LEVEL

COUPLE SYSTEM

FLOW	FIXTURE	HEALING	IMPRESSION COPING	LAB ANALOG	ABUTMENT	SCREW
<p>ø2.9 ø3.3 ø3.7</p>	<p>ø4.3 ø4.8 ø5.5</p>	<p>Closing Screw</p>	<p>Pick-up</p> <p>Hex</p>		<p>Couple</p> <p>Hex</p>	
		<p>Healing Abutment</p>	<p>Transfer</p> <p>Hex</p>		<p>Angled</p> <p>15° 25°</p>	
TOOL	<p>Ratchet Driver</p>	<p>Hex Screw Driver</p>	<p>Hex Screw Driver</p>			<p>Hex Screw Driver</p>

OCTA SYSTEM

FLOW	FIXTURE	HEALING	SUB OCTA ABUTMENT	IMPRESSION COPING	LAB ANALOG	LAB CYLINDER	SCREW
<p>ø3.3 ø3.7 ø4.3</p>	<p>ø4.8 ø5.5</p>	<p>Closing Screw</p>	<p>Octa Healing Cap</p>	<p>Pick-up</p>		<p>Octa</p>	
		<p>Healing Abutment</p>	<p>Octa Abutment</p>	<p>Transfer</p>		<p>N-Octa</p>	
TOOL	<p>Ratchet Driver</p>	<p>Hex Screw Driver</p>	<p>Octa Driver</p>			<p>Octa/N-Octa</p>	<p>Hex Screw Driver</p>

SOLID SYSTEM

FLOW	FIXTURE	HEALING	ABUTMENT	IMPRESSION CAP	LAB ANALOG	PLASTIC COPING
<p>ø3.3 ø3.7 ø4.3</p>	<p>ø4.8 ø5.5</p>	<p>Closing Screw</p>	<p>Solid</p>			<p>Single</p>
		<p>Healing Abutment</p>	<p>Cap</p>			<p>Bridge</p>
TOOL	<p>Ratchet Driver</p>	<p>Hex Screw Driver</p>	<p>Solid Driver</p> <p>Hex Screw Driver</p>			<p>Hex Screw Driver</p>

O-RING SYSTEM

FLOW	FIXTURE	HEALING	O-RING ABUTMENT	O-RING LAB ANALOG	RETAINER
<p>ø3.3 ø3.7 ø4.3</p>	<p>ø4.8 ø5.5</p>	<p>Closing Screw</p>			<p>S-ORR</p>
		<p>Healing Abutment</p>			<p>S-ORRc</p>
TOOL	<p>Ratchet Driver</p>	<p>Hex Screw Driver</p>	<p>O-Ring Driver</p>		<p>S-ORRo</p>

LOCATOR SYSTEM

FLOW	FIXTURE	HEALING	LOCATOR ABUTMENT	LOCATOR LAB ANALOG	INSERTER
	<p>ø3.3 ø3.7 ø4.3 ø4.8 ø5.5</p>	<p>Closing Screw Healing Abutment</p>			
TOOL					
	Ratchet Driver	Hex Screw Driver	Locator Driver		S-LRI

MULTI-UNIT SYSTEM

FLOW	FIXTURE	HEALING	ABUTMENT	IMPRESSION COPING	LAB ANALOG	LAB CYLINDER
	<p>ø3.3 ø3.7 ø4.3 ø4.8 ø5.5</p>	<p>Closing Screw Healing Abutment</p>	<p>Healing Cap Multi-Unit Angled 17° 35°</p>			<p>Plastic Titanium</p>
TOOL						
	Ratchet Driver	Hex Screw Driver	Hex Screw Driver Multi-Unit Driver	Hex Screw Driver		Hex Screw Driver

BONE LEVEL HEALING ABUTMENTS

BONE LEVEL HEALING ABUTMENTS

	ø3.5 <small>only for ø2.9 implant</small>	ø3.7 <small>only for ø3.3 implant</small>	ø4.5	ø5.5	ø6.5
1 mm	-	-	S-BHA4510	S-BHA5510	S-BHA6510
2 mm	-	-	S-BHA4520	S-BHA5520	S-BHA6520
2.5 mm	-	S-BMHA3725	-	-	-
3 mm	S-BNHA3530	-	S-BHA4530	S-BHA5530	S-BHA6530
3.5 mm	-	S-BMHA3735	-	-	-
4 mm	-	-	S-BHA4540	S-BHA5540	S-BHA6540
5 mm	-	S-BMHA3750	S-BHA4550	S-BHA5550	S-BHA6550
6 mm	S-BNHA3560	-	-	-	-
7 mm	-	S-BMHA3770	-	-	-

System » Bone Level
Material » Ti Grade 5 ELI
Driver » Hex Screw Driver

BONE LEVEL SHORT IMPLANT HEALING ABUTMENTS

	ø5.0	ø6.0	ø8.0
2 mm	S-BMHA5020	S-BMHA6020	S-BMHA8020
3 mm	S-BMHA5030	S-BMHA6030	S-BMHA8030

System » Bone Level
Material » Ti Grade 5 ELI
Driver » Hex Screw Driver



BONE LEVEL COUPLE SYSTEM

BONE LEVEL COUPLE ABUTMENTS

	ø3.5 <small>only for ø2.9 implant</small>	ø3.7 <small>only for ø3.3 implant</small>	ø4.5	ø5.5	ø6.5
1 mm	-	S-BMCA37107	S-BCA45107	S-BCA55107	S-BCA65107
2 mm	S-BNCA35207	S-BMCA37207	S-BCA45207	S-BCA55207	S-BCA65207
3 mm	S-BNCA35307	S-BMCA37307	S-BCA45307	S-BCA55307	S-BCA65307
4 mm	S-BNCA35407	S-BMCA37407	S-BCA45407	S-BCA55407	S-BCA65407
5 mm	-	S-BMCA37507	S-BCA45507	S-BCA55507	S-BCA65507
6 mm	S-BNCA35607	-	-	-	-





System » Bone Level
Material » Ti Grade 5 ELI
Torque Value » 25 Ncm
Driver » Hex Screw Driver

BONE LEVEL SHORT IMPLANT COUPLE ABUTMENTS

			
	Ø5.0	Ø6.0	Ø8.0
2 mm	S-BMCA5020	S-BMCA6020	S-BMCA8020
3 mm	S-BMCA5030	S-BMCA6030	S-BMCA8030





System » Bone Level
 Material » Ti Grade 5 ELI
 Torque Value » 25 Ncm
 Driver » Hex Screw Driver

BONE LEVEL ANGLED ABUTMENT

						
	Ø3.5 <small>only for ø2.9 implant</small>	Ø3.7 <small>only for ø3.3 implant</small>	Ø4.5 <small>15° 25°</small>	Ø5.5 <small>15° 25°</small>	Ø6.5 <small>15° 25°</small>	
1 mm (15°)	-	S-BMAA37151	2 mm 15°	S-BAA45152	S-BAA55152	S-BAA65152
2 mm (15°)	S-BNAA35152	S-BMAA37152	2 mm 25°	S-BAA45252	S-BAA55252	S-BAA65252
3 mm (15°)	S-BNAA35153	-	4 mm 15°	S-BAA45154	S-BAA55154	S-BAA65154
4 mm (15°)	-	S-BMAA37154	4 mm 25°	S-BAA45254	S-BAA55254	S-BAA65254





System » Bone Level // Material » Ti Grade 5 ELI // Torque Value » 25 Ncm // Driver » Hex Screw Driver

TEMPORARY ABUTMENTS

			
Ø3.5 <small>only for ø2.9 implant</small>	Ø3.7 <small>only for ø3.3 implant</small>	Ø4.5	Ø5.5
S-BNTA35	S-BMTA37	S-BTA45	S-BTA55

System » Bone Level
 Material » PEEK
 Torque Value » 20 Ncm
 Driver » Hex Screw Driver

BONE LEVEL IMPRESSION COPING PICK UP

				
Ø3.5 <small>only for ø2.9 implant</small>	Ø3.7 <small>only for ø3.3 implant</small>	Ø4.5	Ø5.5	Ø6.5
S-BNICP37	S-BMICP37L S-BMICP37S	S-BICP45L S-BICP45S	S-BICP55L S-BICP55S	S-BICP65L S-BICP65S



System » Bone Level
 Material » Ti Grade 5 ELI

BONE LEVEL SHORT IMPLANT IMPRESSION COPING PICK UP

	
Ø5.0	Ø6.0
S-BMSICP50	S-BMSICP60

System » Bone Level
 Material » Ti Grade 5 ELI

BONE LEVEL IMPRESSION COPING TRANSFER

		
Ø3.5 <small>only for ø2.9 implant</small>	Ø3.7 <small>only for ø3.3 implant</small>	Ø4.5
S-BNICT37	S-BMICT37L S-BMICT37S	S-BIP45



System » Bone Level
 Material » Ti Grade 5 ELI

BONE LEVEL SHORT IMPLANT IMPRESSION COPING TRANSFER

	
S-BMSICT50	S-BMSICT60

System » Bone Level
 Material » Ti Grade 5 ELI



BONE LEVEL FIXTURE LAB ANALOG

		
S-BNFLA <small>only for ø2.9 implant</small>	S-BMFLA <small>only for ø3.3 implant</small>	S-BFLA

System » Bone Level
 Material » Ti Grade 5 ELI

BONE LEVEL SOLID SYSTEM

BONE LEVEL SOLID ABUTMENTS

			
	Ø3.7 <small>only for ø3.3 implant</small>	Ø4.5	Ø5.5
1 mm	S-BMSA3710	S-BSA4510	S-BSA5510
2 mm	S-BMSA3720	S-BSA4520	S-BSA5520
3 mm	S-BMSA3730	S-BSA4530	S-BSA5530
4 mm	S-BMSA3740	S-BSA4540	S-BSA5540
5 mm	S-BMSA3750	S-BSA4550	S-BSA5550

System » Bone Level
 Material » Ti Grade 5 ELI
 Torque Value » 25 Ncm
 Driver » Hex Screw Driver

BONE LEVEL SOLID ABUTMENT IMPRESSION CAP



ϕ 3.7
only for ϕ 3.3 implant
 S-BMSAICap37

ϕ 4.5
 S-BSAICap45

ϕ 5.5
 S-BSAICap55

System » Bone Level Solid System
Material » Plastic

BONE LEVEL SOLID LAB ANALOG



ϕ 3.7
only for ϕ 3.3 implant
 S-BMSALA37

ϕ 4.5
 S-BSALA45

ϕ 5.5
 S-BSALA55

System » Bone Level Solid System
Material » Ti Grade 5 ELI

BONE LEVEL OCTA SYSTEM

BONE LEVEL OCTA ABUTMENTS



only for ϕ 3.3 implant

1 mm S-BMOA10 S-BOA10
2 mm S-BMOA20 S-BOA20
3 mm S-BMOA30 S-BOA30
4 mm S-BMOA40 S-BOA40
5 mm S-BMOA50 S-BOA50

System » Bone Level
Material » Ti Grade 5 ELI
Torque Value » : Abutment Screw
 25 Ncm Occlusal Screw 20 Ncm
Driver » Octa Driver

BONE LEVEL OCTA ABUTMENT HEALING CAP



4 mm S-OAHCap
6 mm S-OAHCapL

System » Octa System
Material » Ti Grade 4

BONE LEVEL OCTA SYSTEM PLASTIC CYLINDER



OCTA S-OAPICy
NON-OCTA S-OAPICyN

System » Octa System
Material » POM

BONE LEVEL OCTA SYSTEM TITANIUM CYLINDER



OCTA S-OATICy
NON-OCTA S-OATICyN

System » Octa System
Material » Ti Grade 5 ELI

BONE LEVEL OCTA SYSTEM IMPRESSION COPING PICK UP



OCTA S-ICOAP
NON-OCTA S-ICOAPN

System » Octa System
Material » Ti Grade 5 ELI

BONE LEVEL OCTA SYSTEM IMPRESSION COPING TRANSFER



OCTA S-ICOAT
NON-OCTA S-ICOATN

System » Octa System
Material » Ti Grade 5 ELI

BONE LEVEL OCTA ABUTMENT LAB ANALOG



S-OALA

System » Octa System
Material » Ti Grade 5 ELI

BONE LEVEL O-RING SYSTEM

BONE LEVEL O-RING ABUTMENTS



only for ϕ 3.3 implant

0.5 mm S-BMORA05 S-BORA05
1 mm - S-BORA10
2 mm S-BMORA20 S-BORA20
3 mm - S-BORA30
4 mm S-BMORA40 S-BORA40
6 mm - S-BORA60

System » Bone Level
Material » Ti Grade 5 ELI
Torque Value » 25 Ncm
Driver » O-Ring Driver

DIRECTIONAL RINGS



S-ORR-A

O-RING LAB ANALOG



S-ORLA

System » O-Ring System
Material » Ti Grade 5 ELI

RETAINER



S-ORR S-ORRc S-ORRo-p S-ORRo-y S-ORRo-g S-ORRo

PINK Soft 900 Gr
YELLOW ExtraSoft 500 Gr
GREEN Elastic 350 Gr

BONE LEVEL LOCATOR SYSTEM

BONE LEVEL MINI LOCATOR ABUTMENTS

only for ø3.3 implant

1.5 mm	S-BMLA15
2.5 mm	S-BMLA25
3.5 mm	S-BMLA35
4.5 mm	S-BMLA45
5.5 mm	S-BMLA55
6.5 mm	S-BMLA65

BONE LEVEL LOCATOR ABUTMENTS

1.5 mm	S-BLA15
2.5 mm	S-BLA25
3.5 mm	S-BLA35
4.5 mm	S-BLA45
5.5 mm	S-BLA55
6.5 mm	S-BLA65



System » Bone Level
Material » Ti Grade 5 ELI
Torque Value » 25 Ncm
Driver » Locator Driver

BONE LEVEL LOCATOR LAB ANALOG



S-BLLA

LOCATOR MATRIX



S-LMht

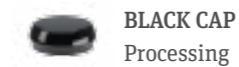

BLACK CAP
Processing



VIOLET CAP
Rigid Retention 2.7 Kg



PINK CAP
Soft Retention 1.2 Kg

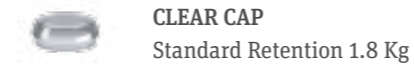

CLEAR CAP
Standard Retention 1.8 Kg



YELLOW CAP
Extra Soft Retention 0.6 Kg

S-LRI

BONE LEVEL MULTI UNIT SYSTEM

MULTI UNIT ABUTMENTS



ø4.8

only for ø3.3 implant

0.5 mm	S-BMMUA4805
1.5 mm	S-BMMUA4815
2.5 mm	S-BMMUA4825
3.5 mm	S-BMMUA4835
4.5 mm	S-BMMUA4845



ø4.8

0.5 mm	S-BMUA4805
1.5 mm	S-BMUA4815
2.5 mm	S-BMUA4825
3.5 mm	S-BMUA4835
4.5 mm	S-BMUA4845

System » Bone Level
Material » Ti Grade 5 ELI
Torque Value » : Abutment Screw
25 Ncm Oclusal Screw 20 Ncm
Driver » Multi Unit Driver

MULTI UNIT ANGLED ABUTMENTS



ø4.8 (17°)

1.0 mm	S-BMUA48171
2.5 mm	S-BMUA48172
3.5 mm	S-BMUA48173



ø4.8 (35°)

1.0 mm	S-BMUA48351
2.5 mm	S-BMUA48352
3.5 mm	S-BMUA48353

System » Bone Level
Material » Ti Grade 5 ELI
Torque Value » : Abutment Screw
25 Ncm Oclusal Screw 20 Ncm
Driver » 1,2 Hex Driver

MULTI UNIT ABUTMENT HEALING CAP



ø4.8

4 mm S-MUAHCap

System » Multi Unit System
Material » Ti Grade 5 ELI

MULTI UNIT IMPRESSION COPING PICK UP



ø4.8

S-BMUAICP

System » Multi Unit System
Material » Ti Grade 5 ELI

MULTI UNIT TRANSFER NON-HEX



ø4.8

S-MUATN

System » Multi Unit System
Material » Ti Grade 5 ELI

MULTI UNIT ABUTMENT PLASTIC CYLINDER



S-MUAPICyN

System » Multi Unit System
Material » POM

MULTI UNIT ABUTMENT TITANIUM CYLINDER



S-MUATICyN

System » Multi Unit System
Material » Ti Grade 5 ELI

MULTI UNIT LAB ANALOG



S-BMUALA
Ø 4.8×14mm

System » Bone Level
Material » Ti Grade 5 ELI

BAR SYSTEM

BAR BURNOUT S-IB



BAR CLIP YELLOW S-IBClip - y Medium Retention 1.8 Kg



TOOL FOR INSERTING CLIP



S-BMIA

BAR POSITIONING S-IBP



BAR CLIP PINK S-IBClip - p Soft Retention 1.2 Kg



KEY FOR PARALLELOMETER



S-TFIC

BAR HOUSING S-IBH



BAR CLIP RED S-IBClip - r Extra Soft Retention 0.8 Kg



TISSUE LEVEL

COUPLE SYSTEM

FLOW	FIXTURE	HEALING	ABUTMENT	LAB ANALOG	ABUTMENT	SCREW
TOOL						

SOLID SYSTEM

FLOW	FIXTURE	HEALING	ABUTMENT	IMPRESSION CAP	LAB ANALOG	PLASTIC COPING
TOOL			 			

OCTA SYSTEM

FLOW	FIXTURE	HEALING	OCTA ABUTMENT	IMPRESSION COPING	LAB ANALOG	LAB CYLINDER	SCREW
 ø3.7 ø4.3-L06 ø4.3	 ø4.8-L06 ø4.8 ø5.5	 Cover Screw Healing Abutment	 Octa	 Pick-up Transfer	 Lab Analog	 Octa N-Octa	 Screw
TOOL	 Ratchet Driver	 Hex Screw Driver	 Octa Driver			 Octa/N-Octa	 Hex Screw Driver

LOCATOR SYSTEM

FLOW	FIXTURE	HEALING	LOCATOR ABUTMENT	LOCATOR LAB ANALOG	INSERTER
 ø3.7 ø4.3-L06 ø4.3	 ø4.8-L06 ø4.8 ø5.5	 Closing Screw Healing Abutment	 Locator Abutment	 Locator Lab Analog	 S-LMHt S-LRI
TOOL	 Ratchet Driver	 Hex Screw Driver	 Locator Driver		 S-LRI

O-RING SYSTEM

FLOW	FIXTURE	HEALING	O-RING ABUTMENT	O-RING LAB ANALOG	RETAINER
 ø3.7 ø4.3-L06 ø4.3	 ø4.8-L06 ø4.8 ø5.5	 Closing Screw Healing Abutment	 O-Ring Abutment	 O-Ring Lab Analog	 S-ORR S-ORRc S-ORRo
TOOL	 Ratchet Driver	 Hex Screw Driver	 O-Ring Driver		 S-ORR

TISSUE LEVEL HEALING ABUTMENTS

TISSUE LEVEL HEALING ABUTMENTS



3.5 mm S-THA35 S-THAW35
 5.5 mm S-THA55 S-THAW55

only for ø5.5 implant

System » Tissue Level
 Material » Ti Grade 4
 Torque Value » 20 Ncm
 Driver » Hex Screw Driver

TISSUE LEVEL COUPLE SYSTEM

TISSUE LEVEL COUPLE ABUTMENTS



1 mm S-TCA10 S-TCAW10
 2 mm S-TCA20 S-TCAW20
 3 mm S-TCA30 S-TCAW30
 4 mm S-TCA40 S-TCAW40

only for ø5.5 implant

System » Tissue Level
 Material » Ti Grade 4
 Torque Value » 25 Ncm
 Driver » Hex Screw Driver

TISSUE LEVEL ANGLED ABUTMENT



15° S-TAA15
 25° S-TAA25

System » Tissue Level
 Material » Ti Grade 4
 Torque Value » 25 Ncm
 Driver » Hex Screw Driver

TISSUE LEVEL SYNOCTA ABUTMENT



6 mm S-TSOA

System » Tissue Level
 Material » Ti Grade 4
 Torque Value » 25 Ncm
 Driver » Hex Screw Driver

TISSUE LEVEL IMPRESSION COPING PICK UP



OCTA S-TICP S-TICPW

only for ø5.5 implant

System » Tissue Level
 Material » Ti Grade 5 ELI

TISSUE LEVEL IMPRESSION COPING TRANSFER



OCTA S-TICT

System » Tissue Level
 Material » Ti Grade 5 ELI

TISSUE LEVEL FIXTURE LAB ANALOG



S-TFLA S-TFLLA

only for ø5.5 implant

System » Tissue Level
 Material » Ti Grade 5 ELI

TISSUE LEVEL SOLID SYSTEM

TISSUE LEVEL SOLID ABUTMENTS



ø3.5 S-TSA40 S-TSAL40
 4 mm S-TSA40 S-TSAL40
 5 mm - S-TSAL55
 5.5 mm S-TSA55 -
 7 mm S-TSA70 S-TSAL70

ø4.5

only for ø5.5 implant

System » Tissue Level
 Material » Ti Grade 4
 Torque Value » 25 Ncm
 Driver » Solid Driver

TISSUE LEVEL SOLID ABUTMENT POSITIONING CYLINDER & IMPRESSION CAP



S-TSAPoCy S-TSAICap

System » Tissue Level Solid System
 Material » Plastic



TISSUE LEVEL SOLID PLASTIC COPING



CROWN S-TSAPICc
 BRIDGE S-TSAPICb

System » Tissue Level Solid System
 Material » POM

TISSUE LEVEL SOLID ABUTMENT LAB ANALOG

		
	only for ø5.5 implant	
4 mm	S-TSALA40	S-TSALLA40
5.5 mm	S-TSALA55	S-TSALLA55
7 mm	S-TSALA70	S-TSALLA70

System » Tissue Level Solid System
Material » Ti Grade 5 ELI

TISSUE LEVEL OCTA SYSTEM

TISSUE LEVEL OCTA ABUTMENT



S-TOA

System » Tissue Level
Material » Ti Grade 4
Torque Value » : Abutment Screw 25 Ncm Oclusal Screw 20 Ncm
Driver » Octa Driver

TISSUE LEVEL OCTA ABUTMENT HEALING CAP



4 mm	S-OAHCap
6 mm	S-OAHCapL

System » Octa System
Material » Ti Grade 5 ELI

TISSUE LEVEL OCTA ABUTMENT PLASTIC CYLINDER OCTA / NON-OCTA



OCTA	S-OAPICy
NON-OCTA	S-OAPICyN

System » Octa System
Material » POM

TISSUE LEVEL OCTA ABUTMENT TITANIUM CYLINDER OCTA / NON-OCTA



OCTA	S-OATICy
NON-OCTA	S-OATICyN

System » Octa System
Material » Ti Grade 5 ELI

TISSUE LEVEL OCTA SYSTEM IMPRESSION COPING PICK UP OCTA / NON-OCTA



ø5.5

OCTA	S-ICOAP
N-OCTA	S-ICOAPN

System » Octa System
Material » Ti Grade 5 ELI

TISSUE LEVEL OCTA SYSTEM IMPRESSION COPING TRANSFER OCTA / NON-OCTA



ø5.0

OCTA	S-ICOAT
N-OCTA	S-ICOATN

System » Octa System
Material » Ti Grade 5 ELI

TISSUE LEVEL OCTA LAB ANALOG



S-OALA

System » Octa System
Material » Ti Grade 5 ELI

TISSUE LEVEL O-RING SYSTEM

TISSUE LEVEL O-RING ABUTMENTS



0.5 mm	S-TORA05
2 mm	S-TORA20
4 mm	S-TORA40

System » Tissue Level
Material » Ti Grade 4
Torque Value » 25 Ncm
Driver » O-Ring Driver

DIRECTIONAL RINGS



S-ORR-A

O-RING LAB ANALOG



S-ORLA

System » O-Ring System
Material » Ti Grade 5 ELI

RETAINER



PINK
Soft 900 Gr

YELLOW
ExtraSoft 500 Gr

GREEN
Elastic 350 Gr

TISSUE LEVEL LOCATOR SYSTEM

TISSUE LEVEL LOCATOR ABUTMENTS



1.5 mm	S-TLA15
2.5 mm	S-TLA25
3.5 mm	S-TLA35
4.5 mm	S-TLA45
5.5 mm	S-TLA55
6.5 mm	S-TLA65

System » Tissue Level
Material » Ti Grade 5 ELI
Torque Value » 25 Ncm
Driver » Locator Driver

TISSUE LEVEL LOCATOR LAB ANALOG



S-TLLA

LOCATOR MATRIX



S-LMHt



S-LRI

ZYGOMA DENTAL IMPLANT SYSTEM

MULTI UNIT ABUTMENT



I-SMUA3050-17(3) - 17°
I-SMUA3050-33(3) - 33°
I-SMUA3050-45(3) - 45°
I-SMUA5050-17(3) - 17°
I-SMUA5050-33(3) - 33°
I-SMUA5050-45(3) - 45°
I-SMUA5050-55(3) - 55°

System » Zygoma // Material » Ti Grade 5 ELI
Torque Value » 25 Ncm // Driver » Hex Screw Driver

MULTI UNIT ABUTMENT HEALING CAP



S-MUAHCap

System » Zygoma // Torque Value » 25 Ncm

MULTI UNIT ABUTMENT PLASTIC CYLINDER



S-MUAPICYN

System » Zygoma // Material » POM

MULTI UNIT ABUTMENT TITANIUM CYLINDER



S-MUATICYN

System » Zygoma // Material » Ti Grade 5 ELI

MULTI UNIT ABUTMENT TRANSFER NON-HEX



S-MUATN

System » Zygoma // Material » Ti Grade 5 ELI

MULTI UNIT IMPRESSION COPING PICK UP



S-BMUAICP

System » Zygoma // Material » Ti Grade 5 ELI

MULTI UNIT LAB ANALOG



S-BMUALA

System » Zygoma // Material » Ti Grade 5 ELI

» **DIGITAL
SOLUTIONS**



BONE LEVEL

SCAN BODY



only for ø3.3 implant
S-PMSB



S-PSB

System » Digital System
Driver » Hex Screw Driver

DIGITAL ANALOG



only for ø3.3 implant
S-BMFDLA



S-BFDLA

System » Digital System
Driver » Hex Screw Driver

PREMILL



only for ø3.3 implant
ø10 mm S-BMPA10
ø14 mm S-BMPA14
ø16 mm -



S-BPA10
S-BPA14
S-BPA16

System » Digital System
Material » Ti Grade 5 ELI
Driver » Hex Screw Driver

TISSUE LEVEL

SCAN BODY



S-TSB



only for ø5.5 implant
S-TWSB

System » Digital System
Driver » Hex Screw Driver

DIGITAL ANALOG



S-TFDLA



only for ø5.5 implant
S-TWFDLA

System » Digital System
Driver » Hex Screw Driver

PREMILL



ø10 mm S-TPA10
ø14 mm S-TPA14
ø16 mm S-TPA16



only for ø5.5 implant
S-TWPA10
S-TWPA14
S-TWPA16

System » Digital System
Material » Ti Grade 5 ELI
Driver » Hex Screw Driver

MULTI UNIT ABUTMENT

SCAN BODY



S-PMUSB

System » Digital System
Driver » Hex Screw Driver

DIGITAL ANALOG



S-BMDLA

System » Digital System
Driver » Hex Screw Driver

ZR BASE



S-MUTB

System » Digital System
Driver » Hex Screw Driver

OCTA ABUTMENT

SCAN BODY



S-POSB

System » Digital System
Driver » Hex Screw Driver

DIGITAL ANALOG



S-BODLA

System » Digital System
Driver » Hex Screw Driver

ZR BASE



S-OTB

System » Digital System
Driver » Hex Screw Driver

Ti-BASE ABUTMENT

Ti-BASE SCAN BODY



only for ø3.3 implant
S-TIMSB



S-TISB

System » Digital System
Driver » Hex Screw Driver

Ti-BASE ABUTMENT



only for ø2.9 implant
S-BNTIA05
S-BNTIA10
S-BNTIA20



only for ø3.3 implant
S-BMTIA05
S-BMTIA10
S-BMTIA20



S-BTIA05
S-BTIA10
S-BTIA20

System » Digital System
Driver » Hex Screw Driver

INDEX CODE

PRODUCT	PLATFORM	HEIGHT	CODE
BONE LEVEL FIXTURES			
BONE LEVEL NARROW HYBRID FIXTURE			
Bone Level Narrow Hybrid Fixture	ø 2.9	10 mm	S-BNFHR2910
Bone Level Narrow Hybrid Fixture	ø 2.9	12 mm	S-BNFHR2912
Bone Level Narrow Hybrid Fixture	ø 2.9	14 mm	S-BNFHR2914
BONE LEVEL MINI FIXTURE			
Bone Level Mini Fixture Straight SRA	ø 3.3	8 mm	S-BMFSR3308
Bone Level Mini Fixture Straight SRA	ø 3.3	10 mm	S-BMFSR3310
Bone Level Mini Fixture Straight SRA	ø 3.3	12 mm	S-BMFSR3312
Bone Level Mini Fixture Straight SRA	ø 3.3	14 mm	S-BMFSR3314
BONE LEVEL SHORT FIXTURE			
Bone Level Short Fixture Straight SRA	ø 4.3	5 mm	S-BMFSR4305
Bone Level Short Fixture Straight SRA	ø 4.3	6 mm	S-BMFSR4306
Bone Level Short Fixture Straight SRA	ø 4.8	5 mm	S-BMFSR4805
Bone Level Short Fixture Straight SRA	ø 4.8	6 mm	S-BMFSR4806
Bone Level Short Fixture Straight SRA	ø 5.5	5 mm	S-BMFSR5505
Bone Level Short Fixture Straight SRA	ø 5.5	6 mm	S-BMFSR5506
BONE LEVEL FIXTURE			
Bone Level Fixture Hybrid SRA	ø 3.7	8 mm	S-BFHR3708
Bone Level Fixture Hybrid SRA	ø 3.7	10 mm	S-BFHR3710
Bone Level Fixture Hybrid SRA	ø 3.7	12 mm	S-BFHR3712
Bone Level Fixture Hybrid SRA	ø 3.7	14 mm	S-BFHR3714
Bone Level Fixture Hybrid SRA	ø 4.3	8 mm	S-BFHR4308
Bone Level Fixture Hybrid SRA	ø 4.3	10 mm	S-BFHR4310
Bone Level Fixture Hybrid SRA	ø 4.3	12 mm	S-BFHR4312
Bone Level Fixture Hybrid SRA	ø 4.3	14 mm	S-BFHR4314
Bone Level Fixture Hybrid SRA	ø 4.8	8 mm	S-BFHR4808
Bone Level Fixture Hybrid SRA	ø 4.8	10 mm	S-BFHR4810
Bone Level Fixture Hybrid SRA	ø 4.8	12 mm	S-BFHR4812
Bone Level Fixture Hybrid SRA	ø 4.8	14 mm	S-BFHR4814
BONE LEVEL WIDE FIXTURE			
Bone Level Wide Fixture Hybrid SRA	ø 5.5	8 mm	S-BWFHR5508
Bone Level Wide Fixture Hybrid SRA	ø 5.5	10 mm	S-BWFHR5510
Bone Level Wide Fixture Hybrid SRA	ø 5.5	12 mm	S-BWFHR5512

PRODUCT	PLATFORM	HEIGHT	CODE
HEALING ABUTMENTS			
Healing Abutment	ø 3.5	3 mm	S-BNHA3530
Healing Abutment	ø 3.5	6 mm	S-BNHA3560
Healing Abutment	ø 3.7	2.5 mm	S-BMHA3725
Healing Abutment	ø 3.7	3.5 mm	S-BMHA3735
Healing Abutment	ø 3.7	5 mm	S-BMHA3750
Healing Abutment	ø 3.7	7 mm	S-BMHA3770
Healing Abutment	ø 4.5	1 mm	S-BHA4510
Healing Abutment	ø 4.5	2 mm	S-BHA4520
Healing Abutment	ø 4.5	3 mm	S-BHA4530
Healing Abutment	ø 4.5	4 mm	S-BHA4540
Healing Abutment	ø 4.5	5 mm	S-BHA4550
Healing Abutment	ø 5.5	1 mm	S-BHA5510
Healing Abutment	ø 5.5	2 mm	S-BHA5520
Healing Abutment	ø 5.5	3 mm	S-BHA5530
Healing Abutment	ø 5.5	4 mm	S-BHA5540
Healing Abutment	ø 5.5	5 mm	S-BHA5550
Healing Abutment	ø 6.5	1 mm	S-BHA6510
Healing Abutment	ø 6.5	2 mm	S-BHA6520
Healing Abutment	ø 6.5	3 mm	S-BHA6530
Healing Abutment	ø 6.5	4 mm	S-BHA6540
Healing Abutment	ø 6.5	5 mm	S-BHA6550
Mini Healing Abutment for Short Implant	ø 5.0	2 mm	S-BMHA5020
Mini Healing Abutment for Short Implant	ø 5.0	3 mm	S-BMHA5030
Mini Healing Abutment for Short Implant	ø 6.0	2 mm	S-BMHA6020
Mini Healing Abutment for Short Implant	ø 6.0	3 mm	S-BMHA6030
Mini Healing Abutment for Short Implant	ø 8.0	2 mm	S-BMHA8020
Mini Healing Abutment for Short Implant	ø 8.0	3 mm	S-BMHA8030
BONE LEVEL COUPLE SYSTEM			
COUPLE ABUTMENTS			
Narrow Couple Abutment H7	ø 3.5	2 mm	S-BNCA35207
Narrow Couple Abutment H7	ø 3.5	3 mm	S-BNCA35307
Narrow Couple Abutment H7	ø 3.5	4 mm	S-BNCA35407
Narrow Couple Abutment H7	ø 3.5	6 mm	S-BNCA35607
Mini Couple Abutment H7	ø 3.7	1 mm	S-BMCA37107
Mini Couple Abutment H7	ø 3.7	2 mm	S-BMCA37207
Mini Couple Abutment H7	ø 3.7	3 mm	S-BMCA37307
Mini Couple Abutment H7	ø 3.7	4 mm	S-BMCA37407
Mini Couple Abutment H7	ø 3.7	5 mm	S-BMCA37507

PRODUCT	PLATFORM	HEIGHT	CODE
Couple Abutment H7	∅ 4.5	1 mm	S-BCA45107
Couple Abutment H7	∅ 4.5	2 mm	S-BCA45207
Couple Abutment H7	∅ 4.5	3 mm	S-BCA45307
Couple Abutment H7	∅ 4.5	4 mm	S-BCA45407
Couple Abutment H7	∅ 4.5	5 mm	S-BCA45507
Couple Abutment H7	∅ 5.5	1 mm	S-BCA55107
Couple Abutment H7	∅ 5.5	2 mm	S-BCA55207
Couple Abutment H7	∅ 5.5	3 mm	S-BCA55307
Couple Abutment H7	∅ 5.5	4 mm	S-BCA55407
Couple Abutment H7	∅ 5.5	5 mm	S-BCA55507
Couple Abutment H7	∅ 6.5	1 mm	S-BCA65107
Couple Abutment H7	∅ 6.5	2 mm	S-BCA65207
Couple Abutment H7	∅ 6.5	3 mm	S-BCA65307
Couple Abutment H7	∅ 6.5	4 mm	S-BCA65407
Couple Abutment H7	∅ 6.5	5 mm	S-BCA65507
Mini Couple Abutment for Short Implant	∅ 5.0	2 mm	S-BMCA5020
Mini Couple Abutment for Short Implant	∅ 5.0	3 mm	S-BMCA5030
Mini Couple Abutment for Short Implant	∅ 6.0	2 mm	S-BMCA6020
Mini Couple Abutment for Short Implant	∅ 6.0	3 mm	S-BMCA6030
Mini Couple Abutment for Short Implant	∅ 8.0	2 mm	S-BMCA8020
Mini Couple Abutment for Short Implant	∅ 8.0	3 mm	S-BMCA8030
ANGLED ABUTMENTS			
Narrow Angled Abutment	∅ 3.5	2 mm 15°	S-BNAA35152
Narrow Angled Abutment	∅ 3.5	3 mm 15°	S-BNAA35153
Mini Angled Abutment	∅ 3.7	1 mm 15°	S-BMAA37151
Mini Angled Abutment	∅ 3.7	2 mm 15°	S-BMAA37152
Mini Angled Abutment	∅ 3.7	4 mm 15°	S-BMAA37154
Angled Abutment	∅ 4.5	2 mm 15°	S-BAA45152
Angled Abutment	∅ 4.5	2 mm 25°	S-BAA45252
Angled Abutment	∅ 4.5	4 mm 15°	S-BAA45154
Angled Abutment	∅ 4.5	4 mm 25°	S-BAA45254
Angled Abutment	∅ 5.5	2 mm 15°	S-BAA55152
Angled Abutment	∅ 5.5	2 mm 25°	S-BAA55252
Angled Abutment	∅ 5.5	4 mm 15°	S-BAA55154
Angled Abutment	∅ 5.5	4 mm 25°	S-BAA55254
Angled Abutment	∅ 6.5	2 mm 15°	S-BAA65152
Angled Abutment	∅ 6.5	2 mm 25°	S-BAA65252
Angled Abutment	∅ 6.5	4 mm 15°	S-BAA65154
Angled Abutment	∅ 6.5	4 mm 25°	S-BAA65254

PRODUCT	PLATFORM	HEIGHT	CODE
TEMPORARY ABUTMENTS			
Narrow Temporary Abutment	∅ 3.5		S-BNTA35
Mini Temporary Abutment	∅ 3.7		S-BMTA37
Temporary Abutment	∅ 4.5		S-BTA45
Temporary Abutment	∅ 5.5		S-BTA55
IMPRESSION COPING PICK UP			
Narrow Impression Coping Pick up	∅ 3.5		S-BNICP37
Mini Impression Coping Pick up	∅ 3.7		S-BMICP37L
Mini Impression Coping Pick up	∅ 3.7		S-BMICP37S
Impression Coping Pick up	∅ 4.5		S-BICP45L
Impression Coping Pick up	∅ 4.5		S-BICP45S
Impression Coping Pick up	∅ 5.5		S-BICP55L
Impression Coping Pick up	∅ 5.5		S-BICP55S
Impression Coping Pick up	∅ 6.5		S-BICP65L
Impression Coping Pick up	∅ 6.5		S-BICP65S
Impression Coping Pick up for short	∅ 5.0		S-BMSICP50
Impression Coping Pick up for short	∅ 6.0		S-BMSICP60
IMPRESSION COPING TRANSFER			
Narrow Impression Coping Transfer	∅ 3.5		S-BNICT37
Mini Impression Coping Transfer	∅ 3.7		S-BMICT37L
Mini Impression Coping Transfer	∅ 3.7		S-BMICT37S
Mini Impression Coping Transfer for short	∅ 5.0		S-BMSICT50
Mini Impression Coping Transfer for short	∅ 6.0		S-BMSICT60
Impression Coping Transfer	∅ 4.5		S-BIP45
FIXTURE LAB ANALOG			
Narrow Fixture Lab Analog	∅ 3.5	12 mm	S-BNFLA
Mini Fixture Lab Analog	∅ 3.3	12 mm	S-BMFLA
Fixture Lab Analog	∅ 4.3	12 mm	S-BFLA
BONE LEVEL SOLID SYSTEM			
SOLID ABUTMENTS			
Mini Solid Abutment	∅ 3.7	1 mm	S-BMSA3710
Mini Solid Abutment	∅ 3.7	2 mm	S-BMSA3720
Mini Solid Abutment	∅ 3.7	3 mm	S-BMSA3730
Mini Solid Abutment	∅ 3.7	4 mm	S-BMSA3740
Mini Solid Abutment	∅ 3.7	5 mm	S-BMSA3750
Solid Abutment	∅ 4.5	1 mm	S-BSA4510
Solid Abutment	∅ 4.5	2 mm	S-BSA4520
Solid Abutment	∅ 4.5	3 mm	S-BSA4530

PRODUCT	PLATFORM	HEIGHT	CODE
Solid Abutment	∅ 4.5	4 mm	S-BSA4540
Solid Abutment	∅ 4.5	5 mm	S-BSA4550
Solid Abutment	∅ 5.5	1 mm	S-BSA5510
Solid Abutment	∅ 5.5	2 mm	S-BSA5520
Solid Abutment	∅ 5.5	3 mm	S-BSA5530
Solid Abutment	∅ 5.5	4 mm	S-BSA5540
Solid Abutment	∅ 5.5	5 mm	S-BSA5550
SOLID ABUTMENT IMPRESSION CAPS			
Mini Solid Abutment Impression Cap	∅ 3.7		S-BMSAICap37
Solid Abutment Impression Cap	∅ 4.5		S-BSAICap45
Solid Abutment Impression Cap	∅ 5.5		S-BSAICap55
SOLID LAB ANALOG			
Mini Solid Lab Analog	∅ 3.7		S-BMSALA37
Solid Lab Analog	∅ 4.5		S-BSALA45
Solid Lab Analog	∅ 5.5		S-BSALA55
BONE LEVEL OCTA SYSTEM			
OCTA ABUTMENTS			
Mini Octa Abutment	∅ 4.8	1 mm	S-BMOA10
Mini Octa Abutment	∅ 4.8	2 mm	S-BMOA20
Mini Octa Abutment	∅ 4.8	3 mm	S-BMOA30
Mini Octa Abutment	∅ 4.8	4 mm	S-BMOA40
Mini Octa Abutment	∅ 4.8	5 mm	S-BMOA50
Octa Abutment	∅ 4.8	1 mm	S-BOA10
Octa Abutment	∅ 4.8	2 mm	S-BOA20
Octa Abutment	∅ 4.8	3 mm	S-BOA30
Octa Abutment	∅ 4.8	4 mm	S-BOA40
Octa Abutment	∅ 4.8	5 mm	S-BOA50
OCTA ABUTMENT HEALING CAP			
Octa Abutment Healing Cap	∅ 4.9	4 mm	S-OAHCAP
Octa Abutment Healing Cap Large	∅ 4.9	6 mm	S-OAHCAP-L
OCTA SYSTEM PLASTIC CYLINDER OCTA			
Octa System Plastic Cylinder Octa	∅ 5.2		S-OAPICy
OCTA SYSTEM PLASTIC CYLINDER NON-OCTA			
Octa System Plastic Cylinder Non-Octa	∅ 5.2		S-OAPICyN
OCTA SYSTEM TITANIUM CYLINDER			
Octa System Plastic Cylinder	∅ 5.2		S-OATICy
OCTA SYSTEM TITANIUM CYLINDER NON-OCTA			
Octa System Plastic Cylinder Non-Hex	∅ 5.2		S-OATICyN
OCTA SYSTEM IMPRESSION COPING PICK UP			
Octa System Impression Coping Pick Up	∅ 5.5	10 mm	S-ICOAP

PRODUCT	PLATFORM	HEIGHT	CODE
OCTA SYSTEM IMPRESSION COPING PICK UP NON-OCTA			
Octa System Impression Coping Pick Up Non-Hex	∅ 5.5	10 mm	S-ICOAPN
OCTA SYSTEM IMPRESSION COPING TRANSFER			
Octa System Impression Coping Transfer	∅ 5.0	7 mm	S-ICOAT
OCTA SYSTEM IMPRESSION COPING TRANSFER NON-OCTA			
Octa System Impression Coping Transfer Non-Hex	∅ 5.0	7 mm	S-ICOATN
OCTA ABUTMENT LAB ANALOG			
Octa Abutment Lab Analog	∅ 4.8	14 mm	S-OALA
BONE LEVEL O-RING SYSTEM			
O-RING ABUTMENTS			
Mini O-Ring Abutment	∅ 2.9	0.5 mm	S-BMORA05
Mini O-Ring Abutment	∅ 3.7	2 mm	S-BMORA20
Mini O-Ring Abutment	∅ 3.7	4 mm	S-BMORA40
O-Ring Abutment	∅ 3.42	0.5 mm	S-BORA05
O-Ring Abutment	∅ 3.42	1 mm	S-BORA10
O-Ring Abutment	∅ 4.5	2 mm	S-BORA20
O-Ring Abutment	∅ 4.5	3 mm	S-BORA30
O-Ring Abutment	∅ 4.5	4 mm	S-BORA40
O-Ring Abutment	∅ 4.5	6 mm	S-BORA60
DIRECTIONAL RINGS			
Directional Rings			S-ORR-A
RETAINERS			
Retainer	∅ 5.5	2 mm	S-ORR
Retainer	∅ 5.5	3.5 mm	S-ORRc
Retainer Pink Cap			S-ORRo-p
Retainer Yellow Cap			S-ORRo-y
Retainer Green Cap			S-ORRo-g
O-RING LAB ANALOG			
O-Ring Lab Analog	∅ 4.1		S-ORLA
BONE LEVEL LOCATOR SYSTEM			
LOCATOR ABUTMENTS			
Locator Mini Abutment	∅ 3.86	1.5 mm	S-BMLA15
Locator Mini Abutment	∅ 3.86	2.5 mm	S-BMLA35
Locator Mini Abutment	∅ 3.86	4.5 mm	S-BMLA45
Locator Mini Abutment	∅ 3.86	5.5 mm	S-BMLA55
Locator Mini Abutment	∅ 3.86	6.5 mm	S-BMLA65

PRODUCT	PLATFORM	HEIGHT	CODE
Locator Abutment	ø 3.86	1.5 mm	S-BLA15
Locator Abutment	ø 3.86	2.5 mm	S-BLA25
Locator Abutment	ø 3.86	3.5 mm	S-BLA35
Locator Abutment	ø 3.86	4.5 mm	S-BLA45
Locator Abutment	ø 3.86	5.5 mm	S-BLA55
Locator Abutment	ø 3.86	6.5mm	S-BLA65

LOCATOR MATRIX

Locator Matrix (includes processing cap)	ø 5.5		S-LMHt
Locator Cap (includes 4 pcs caps)	ø 4.86		S-LRI

LOCATOR ANALOG

Locator Lab Analog	ø 4		S-BLLA
--------------------	-----	--	--------

BONE LEVEL MULTI-UNIT SYSTEM

MULTI-UNIT ANGLED ABUTMENT

Bone Level Multi Unit Angled Abutment	ø 4.8x17	1.0 mm	S-BMUA48171
Bone Level Multi Unit Angled Abutment	ø 4.8x17	2.5 mm	S-BMUA48172
Bone Level Multi Unit Angled Abutment	ø 4.8x17	3.5 mm	S-BMUA48173
Bone Level Multi Unit Angled Abutment	ø 4.8x35	1.0 mm	S-BMUA48351
Bone Level Multi Unit Angled Abutment	ø 4.8x35	2.5 mm	S-BMUA48352
Bone Level Multi Unit Angled Abutment	ø 4.8x35	3.5 mm	S-BMUA48353

MULTI-UNIT ABUTMENT

Bone Level Multi Unit Mini Abutment	ø 4.8	0.5 mm	S-BMMUA4805
Bone Level Multi Unit Mini Abutment	ø 4.8	1.5 mm	S-BMMUA4815
Bone Level Multi Unit Mini Abutment	ø 4.8	2.5 mm	S-BMMUA4825
Bone Level Multi Unit Mini Abutment	ø 4.8	3.5 mm	S-BMMUA4835
Bone Level Multi Unit Mini Abutment	ø 4.8	4.5 mm	S-BMMUA4845

Bone Level Multi Unit Abutment	ø 4.8	0.5 mm	S-BMUA4805
Bone Level Multi Unit Abutment	ø 4.8	1.5 mm	S-BMUA4815
Bone Level Multi Unit Abutment	ø 4.8	2.5 mm	S-BMUA4825
Bone Level Multi Unit Abutment	ø 4.8	3.5 mm	S-BMUA4835
Bone Level Multi Unit Abutment	ø 4.8	4.5 mm	S-BMUA4845

MULTI UNIT HEALING CAP

Multi Unit Healing Cap	ø 4.8	4.0 mm	S-MUAHCAP
------------------------	-------	--------	-----------

MULTI UNIT IMPRESSION COPING PICK UP

Bone Level Multi Unit Impression Coping Pick Up	ø 4.8		S-BMUAICP
---	-------	--	-----------

MULTI UNIT ABUTMENT PLASTIC CYLINDER

Multi Unit Abutment Plastic Cylinder	ø 4.8		S-MUAPICyN
--------------------------------------	-------	--	------------

MULTI UNIT ABUTMENT TITANIUM CYLINDER

Multi Unit Abutment Titanium Cylinder	ø 4.8		S-MUATICyN
---------------------------------------	-------	--	------------

PRODUCT	PLATFORM	HEIGHT	CODE
MULTI UNIT LAB ANALOG			
Multi Unit Abutment Lab Analog	ø 4.8	14 mm	S-BMUALA

BAR SYSTEM

Bar burnout			S-IB
Bar Positioning			S-IBP
Bar Housing			S-IBH
Bar Clip Yellow			S-IBClip-y
Bar Clip Pink			S-IBClip-P
Bar Clip Red			S-IBClip-r
Tool for Inserting Clip			S-BMIA
Key for Parallelometer			S-TFIC

TISSUE LEVEL FIXTURES

TISSUE LEVEL FIXTURE HYBRID

Tissue Level Fixture Hybrid SRA	ø 3.7	8 mm	S-TFHR3708
Tissue Level Fixture Hybrid SRA	ø 3.7	10 mm	S-TFHR3710
Tissue Level Fixture Hybrid SRA	ø 3.7	12 mm	S-TFHR3712
Tissue Level Fixture Hybrid SRA	ø 3.7	14 mm	S-TFHR3714

Tissue Level Fixture Hybrid SRA	ø 4.3	8 mm	S-TFHR4308
Tissue Level Fixture Hybrid SRA	ø 4.3	10 mm	S-TFHR4310
Tissue Level Fixture Hybrid SRA	ø 4.3	12 mm	S-TFHR4312
Tissue Level Fixture Hybrid SRA	ø 4.3	14 mm	S-TFHR4314

Tissue Level Fixture Hybrid SRA	ø 4.8	8 mm	S-TFHR4808
Tissue Level Fixture Hybrid SRA	ø 4.8	10 mm	S-TFHR4810
Tissue Level Fixture Hybrid SRA	ø 4.8	12 mm	S-TFHR4812
Tissue Level Fixture Hybrid SRA	ø 4.8	14 mm	S-TFHR4814

TISSUE LEVEL SHORT FIXTURE STRAIGHT

Tissue Level Short Fixture Straight SRA	ø 4.3	4 mm	S-TFSR4304
Tissue Level Short Fixture Straight SRA	ø 4.3	5 mm	S-TFSR4305
Tissue Level Short Fixture Straight SRA	ø 4.3	6 mm	S-TFSR4306

Tissue Level Short Fixture Straight SRA	ø 4.8	4 mm	S-TFSR4804
Tissue Level Short Fixture Straight SRA	ø 4.8	5 mm	S-TFSR4805
Tissue Level Short Fixture Straight SRA	ø 4.8	6 mm	S-TFSR4806

Tissue Level Short Fixture Straight SRA	ø 5.5	4 mm	S-TWF5504
Tissue Level Short Fixture Straight SRA	ø 5.5	5 mm	S-TWF5505
Tissue Level Short Fixture Straight SRA	ø 5.5	6 mm	S-TWF5506

TISSUE LEVEL WIDE FIXTURE HYBRID

Tissue Level Wide Fixture Hybrid SRA	ø 5.5	8 mm	S-TWFHR5508
Tissue Level Wide Fixture Hybrid SRA	ø 5.5	10 mm	S-TWFHR5510
Tissue Level Wide Fixture Hybrid SRA	ø 5.5	12 mm	S-TWFHR5512

PRODUCT	PLATFORM	HEIGHT	CODE
TISSUE LEVEL HEALING ABUTMENTS			
Tissue Level Healing Abutment	ø 5.2	3.5 mm	S-THA35
Tissue Level Healing Abutment	ø 5.2	5.5 mm	S-THA55
Tissue Level Healing Abutment	ø 6.4	3.5 mm	S-THAW35
Tissue Level Healing Abutment	ø 6.4	5.5 mm	S-THAW55
TISSUE LEVEL COUPLE SYSTEM			
TISSUE LEVEL COUPLE ABUTMENTS			
Tissue Level Couple Abutment	ø 5.2	1 mm	S-TCA10
Tissue Level Couple Abutment	ø 5.2	2 mm	S-TCA20
Tissue Level Couple Abutment	ø 5.2	3 mm	S-TCA30
Tissue Level Couple Abutment	ø 5.2	4 mm	S-TCA40
Tissue Level Couple Abutment Wide	ø 6.4	1 mm	S-TCAW10
Tissue Level Couple Abutment Wide	ø 6.4	2 mm	S-TCAW20
Tissue Level Couple Abutment Wide	ø 6.4	3 mm	S-TCAW30
Tissue Level Couple Abutment Wide	ø 6.4	4 mm	S-TCAW40
TISSUE LEVEL ANGLED ABUTMENTS			
Tissue Level Angled Abutment	ø 3.7	15°	S-TAA15
Tissue Level Angled Abutment	ø 3.7	25°	S-TAA25
TISSUE LEVEL SYNOCTA ABUTMENT OCTA			
Tissue Level Synocta Abutment Octa	ø 3.5	6 mm	S-TSOA
TISSUE LEVEL IMPRESSION COPING PICK UP OCTA			
Tissue Level Impression Coping Pick Up Octa	ø 5.5	11.75 mm	S-TICP
Tissue Level Impression Coping Pick Up Wide Oct	ø 6.4	11.75 mm	S-TICPW
TISSUE LEVEL IMPRESSION COPING TRANSFER			
Tissue Level Impression Coping Transfer Octa	ø 5.5	9 mm	S-TICT
TISSUE LEVEL FIXTURE LAB ANALOG			
Tissue Level Fixture Lab Analog	ø 4.8	14 mm	S-TFLA
Tissue Level Fixture Large Lab Analog	ø 6.0	14 mm	S-TFLLA
TISSUE LEVEL SOLID SYSTEM			
TISSUE LEVEL SOLID ABUTMENTS			
Tissue Level Solid Abutment	ø 3.5	4 mm	S-TSA40
Tissue Level Solid Abutment	ø 3.5	5.5 mm	S-TSA55
Tissue Level Solid Abutment	ø 3.5	7 mm	S-TSA70
Tissue Level Solid Abutment Large	ø 4.5	4 mm	S-TSAL40
Tissue Level Solid Abutment Large	ø 4.5	5 mm	S-TSAL55
Tissue Level Solid Abutment Large	ø 4.5	7 mm	S-TSAL70

PRODUCT	PLATFORM	HEIGHT	CODE
TISSUE LEVEL SOLID ABUTMENT POSITIONING CYLINDER			
Tissue Level Solid Abutment Positioning Cylinder		ø 10.2	S-TSAPoCy
TISSUE LEVEL SOLID ABUTMENT PLASTIC COPING			
Tissue Level Solid Plastic Coping Crown	ø 5.3	10 mm	S-TSAPICc
Tissue Level Solid Plastic Coping Bridge	ø 5.3	10 mm	S-TSAPICb
TISSUE LEVEL SOLID ABUTMENT IMPRESSION CAP			
Tissue Level Solid Abutment Impression Cap	ø 10.2		S-TSAICap
TISSUE LEVEL SOLID ABUTMENT LAB ANALOG			
Tissue Level Solid Abutment Lab Analog	ø 4.8	14 mm	S-TSALA40
Tissue Level Solid Abutment Lab Analog	ø 4.8	15.5 mm	S-TSALA55
Tissue Level Solid Abutment Lab Analog	ø 4.8	17 mm	S-TSALA70
Tissue Level Solid Abutment Large Lab Analog	ø 6.0	14 mm	S-TSALLA40
Tissue Level Solid Abutment Large Lab Analog	ø 6.0	15.5 mm	S-TSALLA55
Tissue Level Solid Abutment Large Lab Analog	ø 6.0	17 mm	S-TSALLA70
TISSUE LEVEL OCTA SYSTEM			
TISSUE LEVEL OCTA ABUTMENT			
Tissue Level Octa Abutment	ø 3.5		S-TOA
OCTA ABUTMENT HEALING CAP			
Octa Abutment Healing Cap	ø 4.9	4 mm	S-OAHCap
Octa Abutment Healing Cap Large	ø 4.9	6 mm	S-OAHCAP-L
TISSUE LEVEL OCTA SYSTEM PLASTIC CYLINDER			
Octa System Plastic Cylinder Octa	ø 5		S-OAPICy
TISSUE LEVEL OCTA ABUTMENT PLASTIC CYLINDER NON-OCTA			
Tissue Level Octa Abutment Plastic Cylinder Non-Octa	ø 5		S-OAPICyN
TISSUE LEVEL OCTA SYSTEM IMPRESSION COPING PICK UP			
Tissue Level Octa System Impression Coping Pick Up Octa	ø 5.5		S-ICOAP
Tissue Level Octa System Impression Coping Pick Up Non-Octa	ø 5.5		S-ICOAPN
TISSUE LEVEL OCTA SYSTEM IMPRESSION COPING TRANSFER			
Tissue Level Octa System Impression Coping Transfer Octa	ø 5.0		S-ICOAT
Tissue Level Octa System Impression Coping Transfer Non-Octa	ø 5.0		S-ICOATN
TISSUE LEVEL OCTA ABUTMENT LAB ANALOG			
Tissue Level Octa Abutment Lab Analog	ø 4.8		S-OALA
TISSUE LEVEL O-RING SYSTEM			
TISSUE LEVEL O-RING ABUTMENTS			
Tissue Level O-Ring Abutment	ø 3.5	0.5 mm	S-TORA05
Tissue Level O-Ring Abutment	ø 3.5	2 mm	S-TORA20

PRODUCT	PLATFORM	HEIGHT	CODE
Tissue Level O-Ring Abutment	ø 3.5	4 mm	S-TORA40
DIRECTIONAL RINGS			
Directional Rings			S-ORR-A
RETAINERS			
Retainer	ø 5.5	2 mm	S-ORR
Retainer	ø 5.5	3.5 mm	S-ORRc
Retainer Pink Cap			S-ORRo-p
Retainer Yellow Cap			S-ORRo-y
Retainer Green Cap			S-ORRo-g
TISSUE LEVEL O-RING LAB ANALOG			
Tissue Level O-Ring Lab Analog	ø 4.1		S-ORLA
TISSUE LEVEL LOCATOR SYSTEM			
TISSUE LEVEL LOCATOR ABUTMENTS			
Tissue Level Locator Abutment	ø 4.9	1.5 mm	S-TLA15
Tissue Level Locator Abutment	ø 4.9	2.5 mm	S-TLA25
Tissue Level Locator Abutment	ø 4.9	3.5 mm	S-TLA35
Tissue Level Locator Abutment	ø 4.9	4.5 mm	S-TLA45
Tissue Level Locator Abutment	ø 4.9	5.5 mm	S-TLA55
Tissue Level Locator Abutment	ø 4.9	6.5 mm	S-TLA65
LOCATOR MATRIX			
Locator Matrix (includes processing cap)	ø 5.5		S-LMht
Locator Cap (includes 4 pcs caps)	ø 4.86		S-LRI
TISSUE LEVEL LOCATOR LAB ANALOG			
Tissue Level Locator Lab Analog			S-TLLA
ZYGOMA IMPLANT			
ZYGOMA FIXTURE			
Zygoma Fixture	ø 4.3	35 mm	S-ZYG35
Zygoma Fixture	ø 4.3	37.5 mm	S-ZYG37.5
Zygoma Fixture	ø 4.3	40 mm	S-ZYG40
Zygoma Fixture	ø 4.3	42.5 mm	S-ZYG42.5
Zygoma Fixture	ø 4.3	45 mm	S-ZYG45
Zygoma Fixture	ø 4.3	47.5 mm	S-ZYG47.5
Zygoma Fixture	ø 4.3	50 mm	S-ZYG50
Zygoma Fixture	ø 4.3	52.5 mm	S-ZYG52.5
Zygoma Fixture	ø 4.3	55 mm	S-ZYG55
Zygoma Fixture	ø 4.3	57.5 mm	S-ZYG57.5
Zygoma Fixture	ø 4.3	60 mm	S-ZYG60
MULTI UNIT IMPRESSION COPING PICK UP			
Multi Unit Impression Coping Pick Up			S-BMUAICP

PRODUCT	PLATFORM	HEIGHT	CODE
ZYGOMA MULTI UNIT ABUTMENT			
Zygoma Multi Unit Abutment 17°			I-SMUA3050-17(3)
Zygoma Multi Unit Abutment 33°			I-SMUA3050-33(3)
Zygoma Multi Unit Abutment 45°			I-SMUA3050-45(3)
Zygoma Multi Unit Abutment 17°			I-SMUA5050-17(3)
Zygoma Multi Unit Abutment 33°			I-SMUA5050-33(3)
Zygoma Multi Unit Abutment 45°			I-SMUA5050-45(3)
Zygoma Multi Unit Abutment 55°			I-SMUA5050-55(3)
MULTI UNIT ABUTMENT PLASTIC CYLINDER			
Multi Unit Abutment Plastic Cylinder			S-MUAPICYN
MULTI UNIT ABUTMENT TITANIUM CYLINDER			
Multi Unit Abutment Titanium Cylinder			S-MUATICYN
MULTI UNIT ABUTMENT TRANSFER NON-HEX			
Multi Unit Abutment Transfer Non-Hex			S-MUATN
MULTI UNIT LAB ANALOG			
Multi Unit Lab Analog			S-BMUALA
MULTI UNIT ABUTMENT HEALING CAP			
Multi Unit Abutment Healing Cap			S-MUAHCAP
DRIVERS			
Implant Drivers (For ratchet and contra angle)			
Bone Level Narrow Fixture Driver Machine			S-BNFMR
Bone Level Narrow Fixture Driver Ratchet			S-BNFDR
Bone Level Mini Fixture Driver Machine Short			S-BMFDMS
Bone Level Mini Fixture Driver Machine Long			S-BMFDML
Bone Level Mini Fixture Driver Ratchet Short			S-BMFDMS
Bone Level Mini Fixture Driver Ratchet Long			S-BMFDRL
Bone Level Fixture Driver Machine Short			S-BFDMS
Bone Level Fixture Driver Machine Long			S-BFDML
Bone Level Fixture Driver Ratchet Short			S-BFDRS
Bone Level Fixture Driver Ratchet Long			S-BFDRL
Tissue Level Fixture Driver Ratchet Short			S-TFDRS
Tissue Level Fixture Driver Ratchet Long			S-TFDRL
Tissue Level Fixture Driver Machine Short			S-TFDMS
Tissue Level Fixture Driver Machine Long			S-TFDML
Hex driver (extra short, short, long, extra long)			S-1.2HDRS / S-1.2HDRL

PRODUCT	PLATFORM	HEIGHT	CODE
Hex Driver Contra Angle (extra short, short, long, extra long)		S-1.2HDRS / S-1.2HDRL	
O-Ring Driver		S-ORADS/L	
Octa Driver		S-OADS/L	
Solid Driver		S-SAD	
Locator Driver		S-LAD	
Multi-Unit Driver		S-MURD	
ORRO Insert Adaptor		S-OIA	
Bar Matrix Insert Adaptor		S-BMIA	

SCREWS

CLOSING SCREW

BONE LEVEL

Bone Level Narrow Closing Screw	∅ 2.60	4.5 mm	S-BNCLS
Bone Level Mini Closing Screw	∅ 2.8	4.5 mm	S-BMCIS
Bone Level Closing Screw	∅ 3.36	6.5 mm	S-BCIS

TISSUE LEVEL

Tissue Level Closing-Screw Small	∅ 3.5	5.35 mm	S-TCISS
Tissue Level Closing-Screw Large	∅ 5.2	6.4mm	S-TCISL
Tissue Level Closing-Screw Wide	∅ 6.4	6.4 mm	S-TCSW

ABUTMENT SCREWS

BONE LEVEL

Bone Level Narrow Abutment Screw	∅ 1.9	6.5 mm	S-BNAS
Bone Level Mini Abutment Screw	∅ 1.5	6.6 mm	S-BMSAS
Bone Level Abutment Screw	∅ 2.3	9.32 mm	S-BAS
Bone Level Multi-Unit Abutment Screw	∅ 1.96	7 mm	S-BMUASS

TISSUE LEVEL

Tissue Level Abutment Screw	∅ 2.5	7.1	S-TAS
-----------------------------	-------	-----	-------

OCCLUSAL SCREW

Octa Abutment Screw	∅ 2.5	4.5 mm	S-OAS
Multi-Unit Abutment Healing Screw	∅ 2.2	4 mm	S-MUAHS

DIGITAL SOLUTIONS

BONE LEVEL SCAN BODY

Bone Level Mini Scan Body			S-PMSB
Bone Level Scan Body			S-PSB

BONE LEVEL DIGITAL ANALOG

Bone Level Mini Digital Analog			S-BMFDLA
Bone Level Digital Analog			S-BFDLA

BONE LEVEL PREMILL

Bone Level Mini Premill		10 mm	S-BMPA10
Bone Level Mini Premill		14 mm	S-BMPA14

PRODUCT	PLATFORM	HEIGHT	CODE
Bone Level Premill		10 mm	S-BPA10
Bone Level Premill		14 mm	S-BPA14
Bone Level Premill		16 mm	S-BPA16

TISSUE LEVEL SCAN BODY

Tissue Level Scan Body			S-TSB
Tissue Level Wide Scan Body			S-TWSB

TISSUE LEVEL DIGITAL ANALOG

Tissue Level Digital Analog			S-TFDLA
Tissue Level Wide Digital Analog			S-TWFDLA

TISSUE LEVEL PREMILL

Tissue Level Mini Premill		10 mm	S-TPA10
Tissue Level Mini Premill		14 mm	S-TPA14
Tissue Level Mini Premill		16 mm	S-TPA16

Tissue Level Premill		10 mm	S-TWPA10
Tissue Level Premill		14 mm	S-TWPA14
Tissue Level Premill		16 mm	S-TWPA16

MULTI UNIT ABUTMENT

Multi Unit Abutment Scan Body			S-PMUSB
Multi Unit Abutment Digital Analog			S-BMDLA
Multi Unit Abutment ZR Base			S-MUTB

OCTA ABUTMENT

Octa Abutment Scan Body			S-POSB
Octa Abutment Digital Analog			S-BODLA
Octa Abutment ZR Base			S-OTB

Ti-BASE ABUTMENT

Ti-Base Narrow Abutment			S-BNTIA05
Ti-Base Narrow Abutment			S-BNTIA10
Ti-Base Narrow Abutment			S-BNTIA20

Ti-Base Mini Abutment			S-BMTIA05
Ti-Base Mini Abutment			S-BMTIA10
Ti-Base Mini Abutment			S-BMTIA20

Ti-Base Abutment			S-BTIA05
Ti-Base Abutment			S-BTIA10
Ti-Base Abutment			S-BTIA20

Ti-BASE SCAN BODY

Ti-Base Mini Scan Body			S-TIMSB
Ti-Base Scan Body			S-TISB

